

**10.0.04—  
2019/  
29481-2:2012**

2

(ISO 29481-2:2012,  
Building information models — Information delivery manual — Part 2: Interaction  
framework,  
IDT)



2019

1	( - )	-
2	70S «	-
3	5 2019 . 280-	-
4	29481-2:2012 «	-
	2.	-
	» (ISO 29481-2:2012 «Building information models — Information delivery manual — Part 2: Interaction framework». IDT).	-
	1.5—2012 ( 3.5).	-
5		-
29	2015 . 62- «	-
	26	-
	».	-
	( 1	-
)	«	-
	»,	-
	«	-
	».	-
	«	-
	».	-
	,	-
	—	-
	(www.gost.ru)	-

1	.....	1
2	.....	1
3	.....	1
4	.....	2
4.1	.....	2
4.2	<b>BIMmIDM</b> .....	2
4.3	<b>IDM</b> .....	2
4.4	.....	3
4.5	.....	3
4.6	.....	5
4.7	.....	6
4.8	.....	6
5	.....	8
5.1	.....	8
5.2	.....	8
	.....	10
	.....	43
	.....	58
	.....	70
	.....	71
	.....	72

10.0.04—2019

(IDM)  
(BIM).

16739-1:2018.

10303-239

2003

VISI.

System of standards on information modeling of buildings and structures. Building information models.  
Information delivery manual. Part 2. Interaction framework

— 2019—09—01

1

•

-

-

2

8

ISO 29481-1. Building information models — Information delivery manual — Part 1: Methodology and format (

1.

3

8

3.1

(Information Delivery Manual. IDM):

3.2

(interaction framework):

3.3

(interaction framework schema):

3.4

(interaction schema):

3.5 (promotor): , \*

3.6 (templates file): , -

3.7 VISI: , -

— VISI « Voorwaarden scheppen voor Invoeren Standaardisatie ICT in de Infrastructuur-  
sector», « - ».

4

4.1

4.2 BIM IDM

29461-1:2016 IDM

4.3

IDM 29481-1:2016.

IDM

IDM

IDM ( 1).

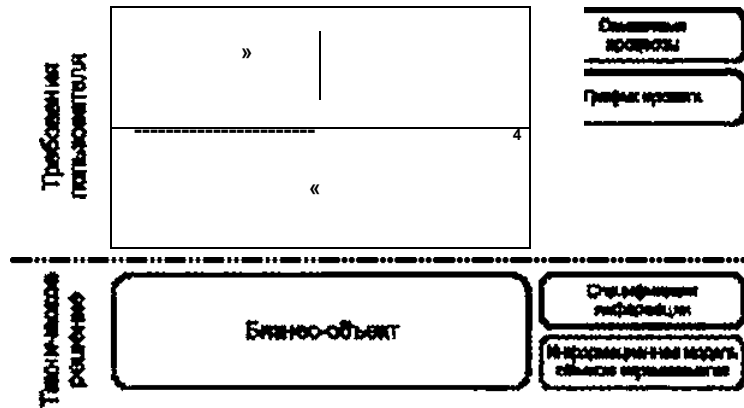

1—

4.4

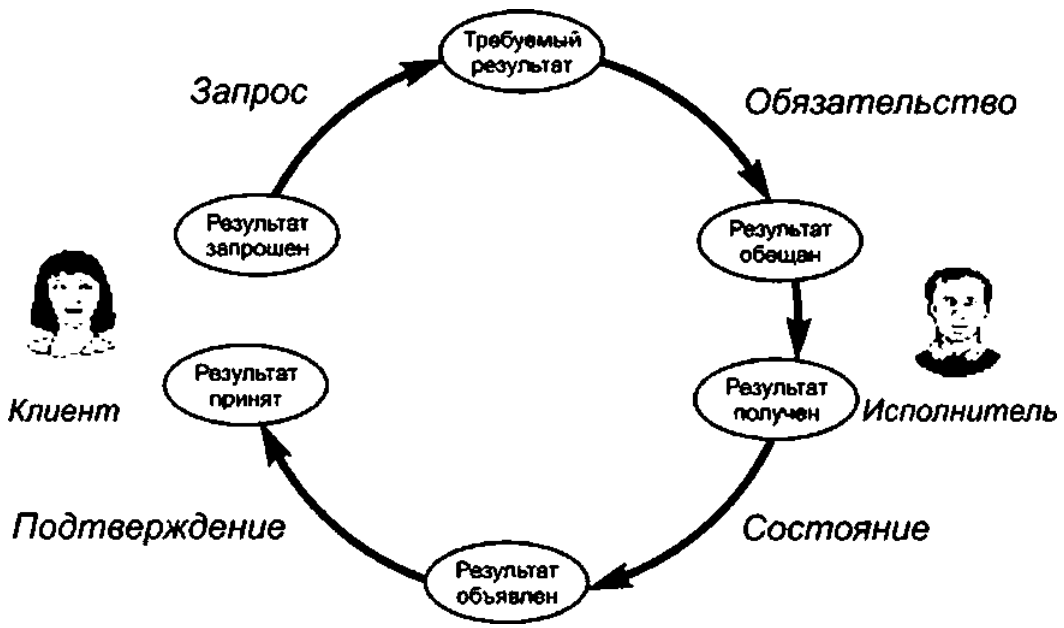

2 — (Dietz J.L.G.. 2006 (1))

4.5

IDM  
) 8  
3

BPMN

BPMN.

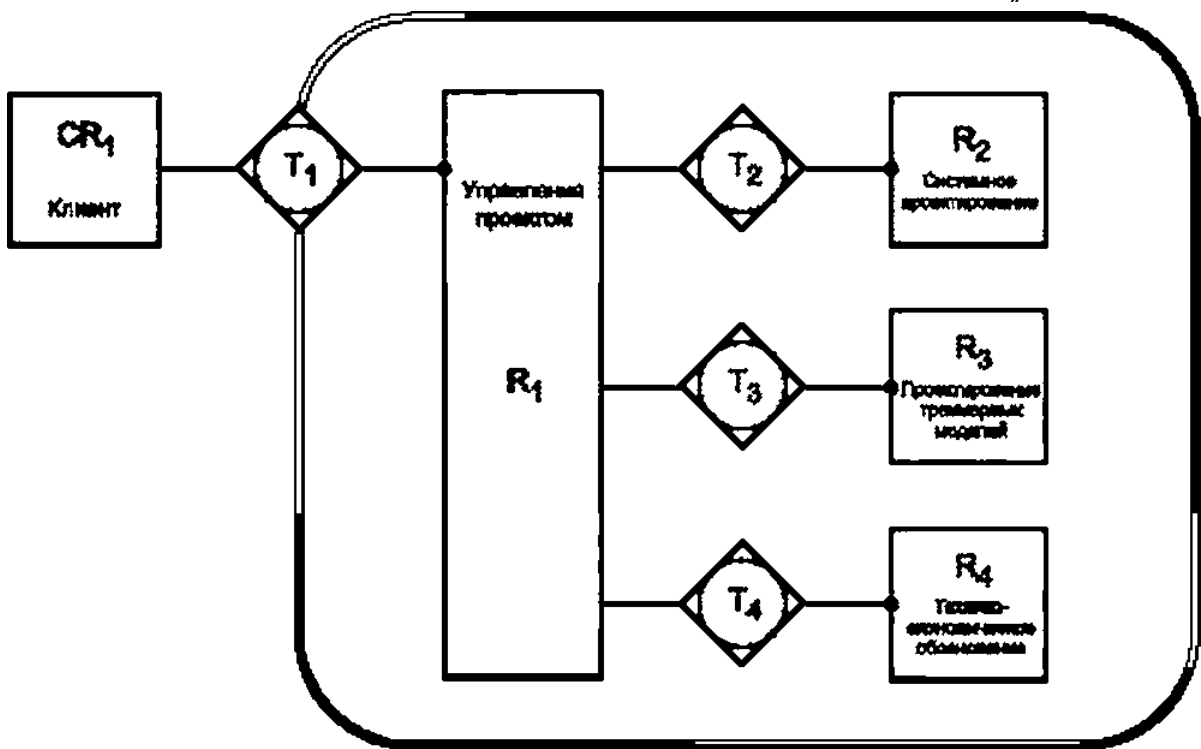
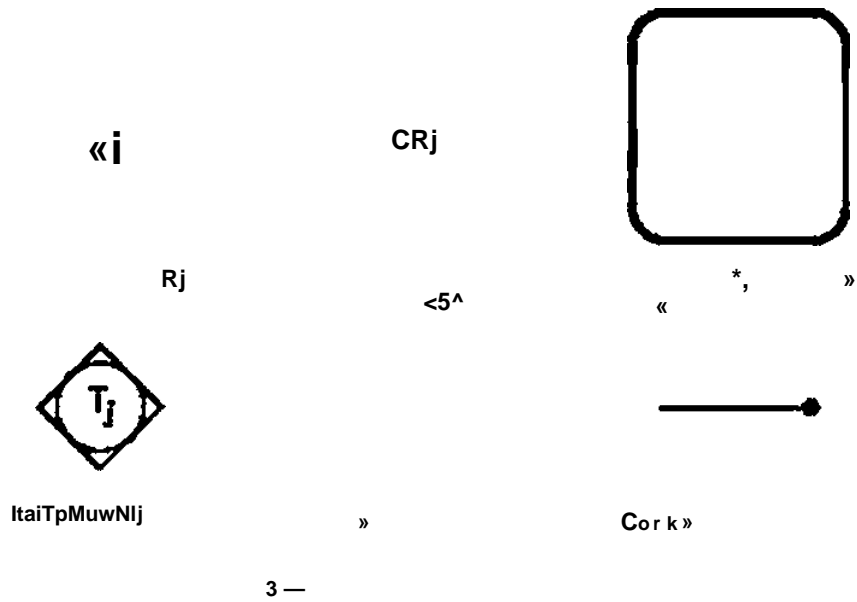



1—

	1.
	2.
	.
	4,

4.6

5

UML.

R1

( R3)

« » ( « »)



: 5"

5—

( BIM)

4.7

-  
.  
-  
-  
\*  
\*  
.

( ) , -

— **SimpleElementType.** **CostEstimation** -  
**CostEstimation** -

( , ) .

4.8

4.8.1

:  
.  
-  
-  
.  
-  
.

8

4.8.2

8  
XSD- XML-  
— (SimpleElementType) (UserdefinedType)

5

4.8.3

, ,  
« » XML XSD. 8 : « ».

(XML),  
 \* (XSD).  
 (XSD).

XSD-

CostEstimation.

CostEstimation.

8  
 8

XSD-

D

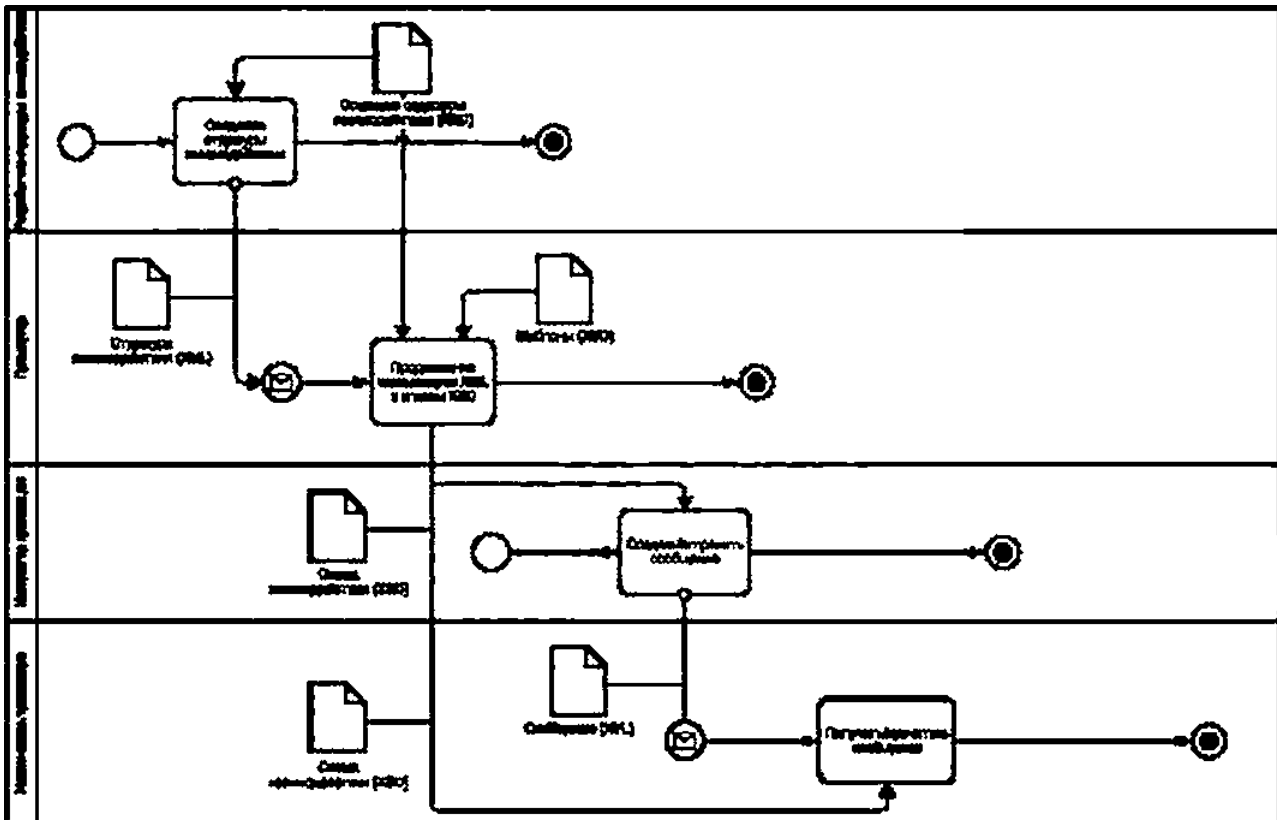

6—

4.8.4

4.8.5

- /
- SOAP-

5

5.1

4.

5.2

XML,

« » , « ».

5.2

5.2.1

XML.

5.2.2 AppendixType

AppendixType —

AppendixType

AppendixType.

5.2.3 ComplexElementType

ComplexElementType

SimpleElementTypes.

SimpleElementType

5.2.4 Elementcondition

Elementcondition

Elementcondition

FIXEO.

ElementCondition

SimpleElement,

Elementcondition

ElementCondition

ComplexElement

MessageInTransactionType.

5.2.5 GroupType

GroupType

GroupType

5.2.6 MessageType

MessageType

ComplexElementType.

5.2.7 MessageInTransactionType

MessageInTransactionType (MITT)

MessageType

TransactionType.

MessageType

MessageType

TransactionType.

TransactionType

MITT

5.2.8 OrganisationType

5.2.9 PersonType

PersonType

5.2.10 ProjectType

5.2.11 RoleType

RoleType

TransactionType

5.2.12 SimpleElementType

SimpleElementType

ComplexElementType

5.2.13 TransactionPhaseType

TransactionPhaseType

5.2.14 TransactionType

5.2.15 userDefinedType

UserDefinedType

XSD.

UserDefinedType

7

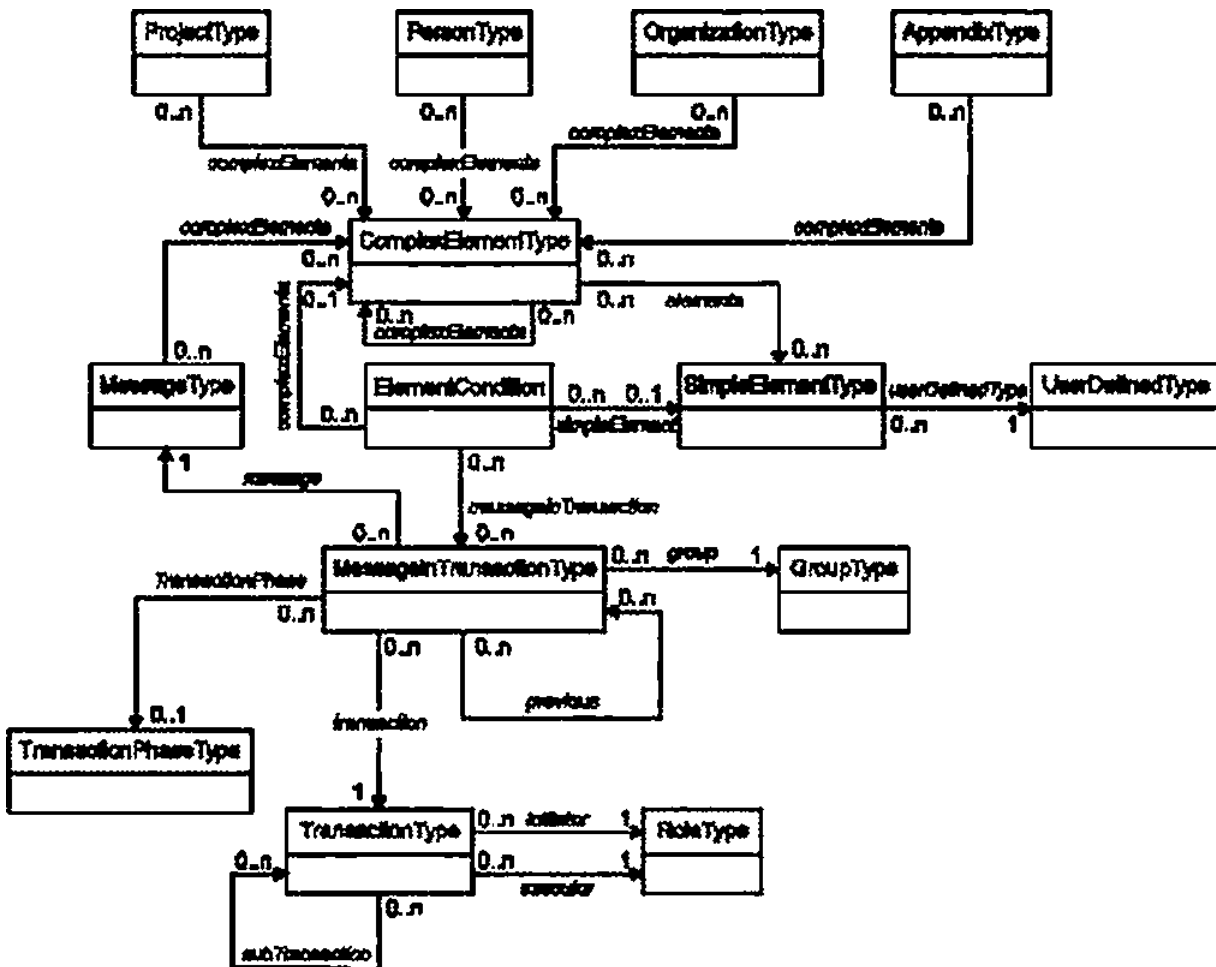

7 —

( )

.1

EXPRESS

XSO.

8

.2

( EXPRESS)<sup>1</sup>)

SCHEMA ISO 29481\_Part\_2A;  
ENTITY ProjedType; —

namespace: STRING;  
description: STRING;  
startDate: DATETIME;  
endDate: DATETIME;  
state: STRING;  
dateLaMu: DATETIME;  
userLaMu: STRING;  
language: OPTIONAL STRING;  
category: OPTIONAL STRING;  
helpinfo: OPTIONAL STRING;  
oode: OPTIONAL STRING;  
complexEJements: OPTIONAL SET [0:?] OF ComptexElementType;  
END\_ENTITY:  
ENTITY PersonType; —

8

description: STRING;  
startDate: DATETIME;  
endDate: DATETIME;  
state: STRING;  
dateLaMu: DATETIME;  
userLaMu: STRING;  
language: OPTIONAL STRING;  
category: OPTIONAL STRING;  
helpinfo: OPTIONAL STRING;  
oode: OPTIONAL STRING;  
complexElements: OPTIONAL SET [0:?] OF ComplexElementType;  
END.ENTITY;  
ENTITY OrganisationType; —

description: STRING;  
startDate: DATETIME;  
endDate: DATETIME;  
state: STRING;  
dateLaMu: DATETIME;  
userLaMu: STRING;  
language: OPTIONAL STRING;  
category: OPTIONAL STRING;  
hetpInfo: OPTIONAL STRING;

29481-2:2012.

code: OPTIONAL STRING;  
 complexElements: OPTIONAL SET [0:?] OF ComplexElementType;  
 END.ENTITY;  
 ENTITY AppendixType; —AppendixType

description: STRING;  
 startDate: DATETIME;  
 endDate: DATETIME;  
 slate: STRING;  
 dateLaMu: DATETIME;  
 userLaMu: STRING;  
 language; OPTIONAL STRING;  
 category; OPTIONAL STRING;  
 belInfo: OPTIONAL STRING;  
 code: OPTIONAL STRING;  
 complexElements: OPTIONAL SET [0:?] OF ComplexElementType;  
 END\_ENTITY;  
 ENTITY ComplexElementType; — ComplexElementType  
 SimpleElementTypes.

description: STRING;  
 startDate: DATETIME;  
 endDate: DATETIME;  
 state: STRING;  
 dateLaMu: DATETIME;  
 userLaMu: STRING;  
 language; OPTIONAL STRING;  
 category; OPTIONAL STRING;  
 belInfo: OPTIONAL STRING;  
 complexElements: OPTIONAL SET [0:?] OF ComplexElementType;  
 simpleElements; OPTIONAL SET [0:?] OF SimpleElementType;  
 END\_ENTITY;  
 ENTITY MessageType; — (MessageType).  
 SimpleElementType ( ComplexElementType)

description: STRING;  
 startDate: DATETIME;  
 endDate: DATETIME;  
 slate: STRING;  
 dateLaMu: DATETIME;  
 userLaMu: STRING;  
 language; OPTIONAL STRING;  
 category; OPTIONAL STRING;  
 belInfo: OPTIONAL STRING;  
 code: OPTIONAL STRING;  
 complexElements: OPTIONAL SET [0:?] OF ComplexElementType;  
 appendixTypes: OPTIONAL SET [1:?] OF AppendixType;  
 END.ENTITY;  
 ENTITY Elementcondition; — SimpleElementType

MessageType.

description: STRING;  
 condition: STRING;  
 belInfo: OPTIONAL STRING;  
 complexElement OPTIONAL ComplexElementType;  
 simpleElement: OPTIONAL SimpleElementType;  
 messageInTransaction: OPTIONAL MessageInTransactionType;  
 END.ENTITY;  
 ENTITY SimpleElementType: — (SimpleElementType).

MessageType (

AppendixType. ProjectType. PersonType OrganisationType). SimpleElementType  
 ComplexElementType.

description: STRING;  
 interfaceType: STRING;  
 state: STRING;

dateLaMu: DATETIME;  
 userLaMu: STRING;  
 language: OPTIONAL STRING;  
 category: OPTIONAL STRING;  
 helpinfo: OPTIONAL STRING;  
 valueList OPTIONAL STRING;  
 userDefinedType: UserDefinedType;  
 END.ENTITY;  
 ENTITY UserDefinedType; — ( SimpleElementType).

8

description: STRING;  
 state: STRING;  
 dateLaMu: DATETIME;  
 userLaMu: STRING;  
 baseType: STRING;  
 xsdRestriction: OPTIONAL STRING;  
 language: OPTIONAL STRING;  
 helpinfo: OPTIONAL STRING;  
 END.ENTITY;  
 ENTITY MessageInTransactionType; — MessageType TransactionType.  
 (GroupType).

requiredNotify: INTEGER;  
 dateLaMu: DATETIME.  
 userLaMu: STRING;  
 received: BOOLEAN;  
 send: BOOLEAN;  
 state: STRING;  
 initiatorToExecutor: OPTIONAL BOOLEAN;  
 openSecondaryTransactionsAllowed: OPTIONAL BOOLEAN;  
 firstMessage; OPTIONAL BOOLEAN;  
 message: MessageType;  
 previous: OPTIONAL SET [0:?] OF MessageInTransactionType;  
 transaction: TransactionType;  
 transactionPhase: OPTIONAL TransactionPhaseType;  
 group: GroupType;  
 appendixTypes: OPTIONAL SET (t:?) OF AppendixType;  
 END.ENTITY;  
 ENTITY TransactionPhaseType; —

description: STRING;  
 startDale: DATETIME;  
 endDate: DATETIME;  
 state: STRING;  
 dateLaMu: DATETIME;  
 userLaMu: STRING;  
 language: OPTIONAL STRING;  
 category: OPTIONAL STRING.  
 helpinfo: OPTIONAL STRING;  
 code: OPTIONAL STRING;  
 END.ENTITY;  
 ENTITY TransactionType: —

description: STRING;  
 startDale: DATETIME;  
 endDate: DATETIME;  
 state: STRING;  
 dateLaMu: DATETIME;  
 userLaMu: STRING;  
 language: OPTIONAL STRING;



```

category: OPTIONAL STRING;
helpInfo: OPTIONAL STRING;
code: OPTIONAL STRING;
result: OPTIONAL STRING;
subTransactions: OPTIONAL SET [1:?] OF TransactionType;
initiator: RoleType;
executor: RoleType;
appendixTypes: OPTIONAL SET [1:?] OF AppendixType;
END.ENTITY;
ENTITY RoleType: —
description: STRING;
startDate: DATETIME;
endDate: DATETIME;
state: STRING;
dateLaMu: DATETIME;
userLaMu: STRING;
language: OPTIONAL STRING;
category: OPTIONAL STRING;
helpInfo: OPTIONAL STRING;
code: OPTIONAL STRING;
responsibilityScope: OPTIONAL STRING;
responsibilityTask: OPTIONAL STRING;
responsibilitySupportTask: OPTIONAL STRING;
responsibilityFeedback: OPTIONAL STRING;
END_ENTITY;
ENTITY GroupType: —
description: STRING;
startDate: DATETIME;
endDate: DATETIME;
state: STRING;
dateLaMu: DATETIME;
userLaMu: STRING;
language: OPTIONAL STRING;
category: OPTIONAL STRING;
helpInfo: OPTIONAL STRING;
END.ENTITY;
END SCHEMA:

```

```

( XSD)
<?xml version="1.0" encoding = "UTF-8"? >
<xsd:schema targetNamespace="http://www. ISO 29481_Part_2A.com/schemas"
xmlns:iso29481p2a = "http://www.ISO29481_Part_2A.com/schemas"
xmlns:xsd - "http://www.w3.org/2001/XMLSchema"
elementFormDefault • "qualified" >
<!-- ( SCHEMA ) --
<xsd:element name="ISO 29481_Part_2A" >
<xsd:complexType>
<xsd:choice maxOccurs="unbounded" >
<xsd:element ref="iso29481p2a:AppendixType"/ >
<xsd:element ref="iso29481p2a:ComplexElementType"/ >
<xsd:element ref="iso29481p2a:Elementcondition"/ >
<xsd:element ref="iso29481p2a:GroupType"/ >
<xsd:element ref="iso29481p2a:MessageInTransactionType"/ >
<xsd:element ref="iso294 81p2a:MessageType"/ >
<xsd:element ref="iso29481p2a:OrganisationType"/ >
<xsd:element ref="iso29481p2a:PersonType"/ >
<xsd:element ref="iso29481p2a:ProjectType"/ >
<xsd:element ref="iso29481p2a:RoleType"/ >
<xsd:element ref="iso29481p2a:SimpleElementType"/ >
<xsd:element ref="iso29481p2a:TransactionPhaseType"/ >
<xsd:element ref="iso29481p2a:TransactionType"/ >
<xsd:element ref="iso29481p2a:UserDefinedType"/ >
</xsd:choice>
</xsd:complexType>
</xsd:element>
<!-- ( ENTITY ) --
<xsd:element name="AppendixType"
type = "iso29481p2a:AppendixTypeType" >
<xsd:annotation>
<xsd:documentation>TMn AppendixType
</xsd:documentation>
</xsd:annotation>
</xsd:element>
<xsd:element name="ComplexElementType"
type = "iso29481p2a:ComplexElementTypeType" >
<xsd:annotation>
<xsd:documentation>CnoxHMft ComplexElementType
SimpleElementTypes.
SimpleElementType
</xsd:documentation>
</xsd:annotation>
</xsd:element>
<xsd:element name="ElementCondition"
type » "iso29481p2a:ElementConditionType" >
<xsd:annotation>
<xsd:documentation>ycnoBne SimpleElementType,
MessageType.</xsd:documentation
</xsd:annotation>
</xsd:element>

```

```

<xsd:element name="GroupType" type = "iso29481p2a:GroupTypeType" >
  <xsd:annotation?
    <xsd:documentation1 >0
      .</xsd:documentation?
    </xsd:annotation?
  </xsd:element?
  <xsd:element name="MessageInTransactionType"
type = "iso29481p2a:MessageInTransactionTypeType" >
  <xsd:annotation?
    <xsd:documentation>Bo3HMKHOseHne MessageType TransactionType,
      (GroupType).</xsd:documentation?
    </xsd:annotation?
  </xsd:element?
  <xsd:element name="MessageType" type « "iso29481p2a:MessageTypeType" >
  <xsd:annotation?
    <xsd:documentation?OnpefleneHHe (MessageType),
      SimpleElementType (
ComplexElementType) .</xsd:documentation?
    </xsd:annotation?
  </xsd:element?
  <xsd:element name="OrganisationType"
type "iso29481p2a:OrganisationTypeType" ?
  <xsd:annotation?
    <xsd:documentation>OnpeaeJieHMe
      ,
      ,
      ,
      .</xsd:documentation?
    </xsd:annotation?
  </xsd:element?
  <xsd:element name="PersonType" type = "iso29481p2a:PersonTypeType" ?
  <xsd:annotation?
    <xsd:documentations-
      ,
      ,
      ,
      .</xsd:documentation?
    </xsd:annotation?
  </xsd:element?
  <xsd:element name="ProjectType" type = "iso29481p2a:ProjectTypeType" ?
  <xsd:annotation?
    <xsd:documentation?OnpefleneHne
      ,
      ,
      ,
      .</xsd:documentation?
    </xsd:annotation?
  </xsd:element?
  <xsd:element name="RoleType" type • "iso29481p2a:RoleTypeType" ?
  <xsd:annotation?
    <xsd:documentation?OnpefleneHHe
      .</xsd:documentation?
    </xsd:annotation?
  </xsd:element?
  <xsd:element name="SimpleElementType"
type a "iso29481p2a:SimpleElementTypeType" ?

```

```

    <xsd:annotation>
      <xsd:documentation>OnpeneneHne
(SimpleElementType).
      ,
      , MessageType (
      AppendixType, ProjectType, PersonType OrganisationType).
SimpleElementType
ComplexElementType.</xsd:documentation>
    </xsd:annotation>
  </xsd:element>
  <xsd:element name="TransactionPhaseType"
type = "iso29481p2a:TransactionPhaseTypeType" >
    <xsd:annotation>
      <xsd:documentation>OnpefleneHMe
      "
      * "
      ".</xsd:documentation>
    </xsd:annotation>
  </xsd:element>
  <xsd:element name="TransactionType"
type = "iso29481p2a:TransactionTypeType" >
    <xsd:annotation>
      <xsd:documentation>OnpefleneHHe
      .
      ,
      ,
      ,
      (
      ).
    </xsd:documentation>
  </xsd:annotation>
</xsd:element>
  <xsd:element name="UserDefinedType"
type = "iso29481p2a:UserDefinedTypeType" >
    <xsd:annotation>
      <xsd:documentation>Cneun4>MKauHfl
      (
SimpleElementType).</xsd:documentation>
    </xsd:annotation>
  </xsd:element>
  <!-- ( ENTITY )--
  <xsd:element name="AppendixTypeRef"
type = "iso29481p2a:AppendixTypeTypeRef" / >
  <xsd:element name="ComplexElementTypeRef"
type = "iso29481p2a:ComplexElementTypeTypeRef" / >
  <xsd:element name="ElementConditionRef"
type = "iso29481p2a:ElementConditionTypeRef" / >
  <xsd:element name="GroupTypeRef"
type = "iso29481p2a:GroupTypeTypeRef" / >
  <xsd:element name="MessageInTransactionTypeRef"
type = "iso29481p2a:MessageInTransactionTypeTypeRef" / >
  <xsd:element name="Message3ageTypeRef"
type = "iso29481p2a:MessageTypeTypeRef" / >
  <xsd:element name="OrganisationTypeRef"
type = "iso29481p2a:OrganisationTypeTypeRef" / >
  <xsd:element name="PersonTypeRef"
type = "iso29481p2a:PersonTypeTypeRef" / >

```

```

<xsd:element name="ProjectTypeRef"
type "iso29481p2a:ProjectTypeTypeRef"/ >
<xsd:element name="RoleTypeRef"
type = "iso29491p2a:RoleTypeTypeRef"/ >
<xsd:element name="SimpleElementTypeRef"
type = "iso29481p2a:SimpleElementTypeTypeRef"/ >
<xsd:element name="TransactionPhaseTypeRef" type = "iso29481p2a:Transact
ionPhaseTypeTypeRef"/ >
<xsd:element name="TransactionTypeRef"
type = "iso29481p2a:TransactionTypeTypeRef"/ >
<xsd:element name="(UserDefinedTypeRef"
type = "iso29481p2a:UserDefinedTypeTypeRef"/ >
<!-- ( ENTITY )-->
<xsd:complexType name="AppendixTypeType" >
<xsd:complexContent>
<xsd:extension base="iso29481p2a:elementType" >
<xsd:sequence>
<xsd:element name="description" type = "xsd:string"/
<xsd:element name="startDate" type = "xsd:dateTime"/
<xsd:element name="endDate" type = "xsd:dateTime"/ >
<xsd:element name="state" type « "xsd:string"/ >
<xsd:element name="dateLaMu" type = "xsd:dateTime"/ >
<xsd:element name="userLaMu" type = "xsd:string"/ >
<xsd:element name="language" type * "xsd:string"
minOccurs = "0"/ >
<xsd:element name="category" type = "xsd:string"
minOccurs = "0"/ >
<xsd:element name="helpInfo" type « "xsd:string"
minOccurs = "0"/ >
<xsd:element name="code" type = "xsd:string"
minOccurs = "0"/ >
<xsd:element name="complexElements" minOccurs = "0" >
<xsd:complexType>
<xsd:choice maxOccurs="unbounded" >
<xsd:element ref="iso29481p2a:ComplexElementType"/ >
<xsd:element
ref="iso29481p2a:ComplexElementTypeRef"/ >
</xsd:choice>
</xsd:complexType>
</xsd:element>
</xsd:sequence>
</xsd:extension>
</xsd:complexContent>
</xsd:complexType>
<xsd:complexType name="ComplexElementTypeType" >
<xsd:complexContent>
<xsd:extension base="iso29481p2a:elementType" >
<xsd:sequence>
<xsd:element name="description" type = "xsd:string"/ >
<xsd:element name="startDate" type = "xsd:dateTime"/ >
<xsd:element name="endDate" type = "xsd:dateTime"/ >
<xsd:element name="state" type « "xsd:string"/ >
<xsd:element name="dateLaMu" type = "xsd:dateTime"/ >

```

```

        <xsd:element name="userLaMu" type = "xsd:string"/ >
        <xsd:element name="language" type = "xsd:string"
minOccurs = "0"/ >
        <xsd:element name="category" type = "xsd:string"
minOccurs = "0"/ >
        <xsd:element name="helpInfo" type = "xsd:string"
minOccurs = "0"/ >
        <xsd:element name="complexElements" minOccurs = "0" >
            <xsd:complexType>
                <xsd:choice maxOccurs="unbounded" >
                    <xsd:element ref="iso29481p2a:ComplexElementType"/ >
                    <xsd:element
ref="iso29481p2a:ComplexElementTypeRef"/ >
                </xsd:choice>
            </xsd:complexType>
        </xsd:element>
        <xsd:element name="simpleElements" minOccurs = "0" >
            <xsd:complexType>
                <xsd:choice maxOccurs="unbounded" >
                    <xsd:element ref="iso29481p2a:SimpleElementType"/ >
                    <xsd:element
ref="iso29481p2a:SimpleElementTypeRef"/ >
                </xsd:choice>
            </xsd:complexType>
        </xsd:element>
    </xsd:sequence>
</xsd:extension>
</xsd:complexContent>
</xsd:complexType>
<xsd:complexType name="ElementConditionType" >
    <xsd:complexContent>
        <xsd:extension base="iso29481p2a:elementType" >
            <xsd:sequence>
                <xsd:element name="description" type = "xsd:string"/ >
                <xsd:element name="condition" type = "xsd:string"/ >
                <xsd:element name="helpInfo" type = "xsd:string"
minOccurs = "0"/ >
            <xsd:element name="complexElement" minOccurs = "0" >
                <xsd:complexType>
                    <xsd:choice>
                        <xsd:element ref="iso29481p2a:ComplexElementType"/ >
                        <xsd:element
ref="iso29481p2a:ComplexElementTypeRef"/ >
                    </xsd:choice>
                </xsd:complexType>
            </xsd:element>
            <xsd:element name="simpleElement" minOccurs = "0" >
                <xsd:complexType>
                    <xsd:choice>
                        <xsd:element ref="iso29481p2a:SimpleElementType"/ >
                        <xsd:element
ref="iso29481p2a:SimpleElementTypeRef"/ >
                    </xsd:choice>
                </xsd:complexType>
            </xsd:element>
        </xsd:extension>
    </xsd:complexContent>
</xsd:complexType>

```

```

        </xsd:complexType>
    </xsd:element>
    <xsd:element name="" messageInTransaction" minOccurs "0" >
        <xsd:complexType>
            <xsd:choice>
                <xsd:element
ref="iso29481p2a:MessageInTransactionType"/ >
                <xsd:element
ref="iso29481p2a:MessageInTransactionTypeRef"/ >
            </xsd:choice>
        </xsd:complexType>
    </xsd:element>
</xsd:sequence>
</xsd:extension>
</xsd:complexContent>
</xsd:complexType>
<xsd:complexType name="GroupTypeType" >
    <xsd:complexContent>
        <xsd:extension base="iso29481p2a:elementType" >
            <xsd:sequence>
                <xsd:element name="description" type "xsd:string"/ >
                <xsd:element name="startDate" type = "xsd:dateTime"/ >
                <xsd:element name="endDate" type = "xsd:dateTime"/ >
                <xsd:element name="state" type = "xsd:string"/ >
                <xsd:element name="dateLaMu" type "xsd:dateTime"/ >
                <xsd:element name="userLaMu" type - "xsd:string"/ >
                <xsd:element name="language" type - "xsd:string"/ >
            </xsd:sequence>
            <xsd:element name="category" type = "xsd:string"/ >
            <xsd:element name="helpInfo" type = "xsd:string"/ >
        </xsd:extension>
    </xsd:complexContent>
</xsd:complexType>
<xsd:complexType name="MessageInTransactionTypeType" >
    <xsd:complexContent>
        <xsd:extension base="iso29481p2a:elementType" >
            <xsd:sequence>
                <xsd:element name="requiredNotify" type - "xsd:integer"/ >
                <xsd:element name="dateLaMu" type = "xsd:dateTime"/ >
                <xsd:element name="userLaMu" type = "xsd:string"/ >
                <xsd:element name="received" type = "xsd:boolean"/ >
                <xsd:element name="send" type = "xsd:boolean"/ >
                <xsd:element name="estate" type - "xsd:string"/ >
                <xsd:element name="initiatorToExecutor" type = "xsd:boolean"/ >
            </xsd:sequence>
            <xsd:element name="openSecondaryTransactionsAllowed"
type = "xsd:boolean" minOccurs = "0"/ >
            <xsd:element name="firstMessage" type = "xsd:boolean"
minOccurs = "0"/ >
            <xsd:element name="message" >

```

```

    <xsd:complexType>
      <xsd:choice>
        <xsd:element ref="iso29481p2a:MessageType"/ >
        <xsd:element ref="iso29481p2a:MessageTypeRef"/ >
      </xsd:choice>
    </xsd:complexType>
  </xsd:element>
  <xsd:element name="previous" minOccurs = "0" >
    <xsd:complexType>
      <xsd:choice maxOccurs="unbounded" >
        <xsd:element
ref="iso29481p2a:MessageInTransactionType"/ >
        <xsd:element
ref="iso29481p2a:MessageInTransactionTypeRef"/ >
      </xsd:choice>
    </xsd:complexType>
  </xsd:element>
  <xsd:element name="transaction" >
    <xsd:complexType>
      <xsd:choice>
        <xsd:element ref="iso29481p2a:TransactionType"/ >
        <xsd:element ref="iso29481p2a:TransactionTypeRef"/ >
      </xsd:choice>
    </xsd:complexType>
  </xsd:element>
  <xsd:element name="transactionPhase" minOccurs = "0" >
    <xsd:complexType>
      <xsd:choice>
        <xsd:element
ref="iso29481p2a:TransactionPhaseType"/ >
        <xsd:element
ref="iso29481p2a:TransactionPhaseTypeRef"/ >
      </xsd:choice>
    </xsd:complexType>
  </xsd:element>
  <xsd:element name="group" >
    <xsd:complexType>
      <xsd:choice>
        <xsd:element ref="iso29481p2a:GroupType"/ >
        <xsd:element ref="iso29481p2a:GroupTypeRef"/ >
      </xsd:choice>
    </xsd:complexType>
  </xsd:element>
  <xsd:element name="appendixTypes" minOccurs = "0" >
    <xsd:complexType>
      <xsd:choice maxOccurs="unbounded" >
        <xsd:element ref="iso29481p2a:AppendixType"/ >
        <xsd:element ref="iso29481p2a:AppendixTypeRef"/ >
      </xsd:choice>
    </xsd:complexType>
  </xsd:element>
</xsd:sequence>
</xsd:extension>

```



```

</xsd:complexContent>
</xsd:complexType>
<xsd:complexType name="MessageType" >
  <xsd:complexContent>
    <xsd:extension base="iso29481p2a:elementType" >
      <xsd:sequence>
        <xsd:element name="description" type="xsd:string"/ >
        <xsd:element name="startDate" type="xsd:dateTime"/ >
        <xsd:element name="endDate" type="xsd:dateTime"/ >
        <xsd:element name="state" type="xsd:string"/ >
        <xsd:element name="dateLaMu" type="xsd:dateTime"/ >
        <xsd:element name="userLaMu" type="xsd:string"/ >
        <xsd:element name="language" type="xsd:string"
minOccurs="0"/ >
        <xsd:element name="category" type="xsd:string"
minOccurs="0"/ >
        <xsd:element name="helpInfo" type="xsd:string"
minOccurs="0"/ >
        <xsd:element name="code" type="xsd:string"
minOccurs="0"/ >
        <xsd:element name="complexElements" minOccurs="0" >
          <xsd:complexType>
            <xsd:choice maxOccurs="unbounded" >
              <xsd:element ref="iso29481p2a:ComplexElementType"/ >
              <xsd:element
ref="iso29481p2a:ComplexElementRef"/ >
            </xsd:choice>
          </xsd:complexType>
        </xsd:element>
        <xsd:element name="appendixTypes" minOccurs="0" >
          <xsd:complexType>
            <xsd:choice maxOccurs="unbounded" >
              <xsd:element ref="iso29481p2a:AppendixType"/ >
              <xsd:element ref="iso29481p2a:AppendixTypeRef"/ >
            </xsd:choice>
          </xsd:complexType>
        </xsd:element>
      </xsd:sequence>
    </xsd:extension>
  </xsd:complexContent>
</xsd:complexType>
<xsd:complexType name="OrganisationType" >
  <xsd:complexContent>
    <xsd:extension base="iso29481p2a:elementType" >
      <xsd:sequence>
        <xsd:element name="description" type="xsd:string"/ >
        <xsd:element name="startDate" type="xsd:dateTime"/ >
        <xsd:element name="endDate" type="xsd:dateTime"/ >
        <xsd:element name="state" type="xsd:string"/ >
        <xsd:element name="dateLaMu" type="xsd:dateTime"/ >
        <xsd:element name="userLaMu" type="xsd:string"/ >
        <xsd:element name="language" type="xsd:string"
minOccurs="0"/ >

```

```

        <xsd:element          name="category" type = "xsd:string"
minOccurs      - "0"/ >
        <xsd:element          name="helpInfo" type = "xsd:string"
minOccurs      = "0"/ >
        <xsd:element          name="code" type = "xsd:string"
minOccurs      = "0"/ >
        <xsd:element          name="complexElements" minOccurs = "0" >
            <xsd:complexType>
                <xsd:choice maxOccurs="unbounded" >
                    <xsd:element ref="iso29481p2a:ComplexElementType"/ >
                    <xsd:element
ref="iso29481p2a:ComplexElementTypeRef"/ >
                </xsd:choice>
            </xsd:complexType>
        </xsd:element>
    </xsd:sequence>
</xsd:extension>
</xsd:complexContent>
</xsd:complexType>
<xsd:complexType name="PersonType" >
    <xsd:complexContent>
        <xsd:extension base="iso29481p2a:elementType" >
            <xsd:sequence>
                <xsd:element          name="description" type = "xsd:string"/ >
                <xsd:element          name="startDate" type = "xsd:dateTime"/ >
                <xsd:element          name="endDate" type = "xsd:dateTime"/ >
                <xsd:element          name="state" type = "xsd:string"/ >
                <xsd:element          name="dateLaMu"          type = "xsd:dateTime"/ >
                <xsd:element          name="userLaMu"          type = "xsd:string"/ >
                <xsd:element          name="language"          type = "xsd:string"
minOccurs = "0"/ >
            <xsd:element          name="category"          type = "xsd:string"
minOccurs = "0"/ >
            <xsd:element          name="helpInfo"          type = "xsd:string"
minOccurs = "0"/ >
            <xsd:element          name="code" type = "xsd:string"
minOccurs = "0"/ >
            <xsd:element          name="complexElements" minOccurs
" " >
                <xsd:complexType>
                    <xsd:choice maxOccurs="unbounded" >
                        <xsd:element ref="iso29481p2a:ComplexElementType"/ >
                        <xsd:element
ref="iso29481p2a:ComplexElementTypeRef"/ >
                    </xsd:choice>
                </xsd:complexType>
            </xsd:element>
        </xsd:sequence>
    </xsd:extension>
</xsd:complexContent>
</xsd:complexType>
<xsd:complexType name="ProjectType" >
    <xsd:complexContent>
        <xsd:extension base="iso29481p2a:elementType" >

```

```

        <xsd:sequence>
        <xsd:element name="namespace" type = "xsd:string"/ >
        <xsd:element name="description" type = "xsd:string"/ >
        <xsd:element name="startDate" type = "xsd:dateTime"/ >
        <xsd:element name="endDate" type = "xsd:dateTime"Z >
        <xsd:element name="state" type = "xsd:string"/ >
        <xsd:element name="dateLaMu" type = "xsd:dateTime"/ >
        <xsd:element name="userLaMu" type = "xsd:string"/ >
        <xsd:element name="language" type = "xsd:string"
minOccurs = "0"/ >
        <xsd:element name="category" type = "xsd:string"
minOccurs = "0"/ >
        <xsd:element name="helpInfo" type = "xsd:string"
minOccurs = "0"/ >
        <xsd:element name="code" type = "xsd:string"
minOccurs = "0"/ >
        <xsd:element name="@complexElements" minOccurs = "0" >
        <xsd:complexType>
        <xsd:choice minOccurs="unbounded" >
        <xsd:element ref="iso29481p2a:ComplexElementType"/ >
        <xsd:element
ref="iso29481p2a:ComplexElementTypeRef"/ >
        </xsd:choice>
        </xsd:complexType>
        </xsd:element>
        </xsd:sequence>
        </xsd:extension>
        </xsd:complexContent>
</xsd:complexType>
<xsd:complexType name="RoleTypeType" >
        <xsd:complexContent>
        <xsd:extension base="iso29481p2a:elementType" >
        <xsd:sequence>
        <xsd:element name="description" type = "xsd:string"/ >
        <xsd:element name="startDate" type = "xsd:dateTime"/ >
        <xsd:element name="endDate" type = "xsd:dateTime"/ >
        <xsd:element name="state" type = "xsd:string"/ >
        <xsd:element name="dateLaMu" type = "xsd:dateTime"/ >
        <xsd:element name="userLaMu" type = "xsd:string"/ >
        <xsd:element name="language" type = "xsd:string"
minOccurs = "0"/ >
        <xsd:element name="category" type = "xsd:string"
minOccurs = "0"/ >
        <xsd:element name="helpInfo" type = "xsd:string"
minOccurs = "0"/ >
        <xsd:element name="code" type = "xsd:string"
minOccurs = "0"/ >
        <xsd:element name="responsibilityScope" type = "xsd:string"
minOccurs = "0"/ >
        <xsd:element name="responsibilityTask" type = "xsd:string"
minOccurs = "0"/ >
        <xsd:element name="responsibilitySupportTask"
type = "xsd:string" minOccurs = "0"/ >

```

```

        <xsd:element name="responsibilityFeedback"
type • "xsd:string" minOccurs » "0"/ >
    </xsd:sequence>
</xsd:extension>
</xsd:complexContent>
</xsd:complexType>
<xsd:complexType name="SimpleElementType" >
    <xsd:complexContent>
        <xsd:extension base="iso29481p2a:elementType" >
            <xsd:sequence>
                <xsd:element name="description" type "xsd:string"/ >
                <xsd:element name="interfaceType" type = "xsd:string"/ >
                <xsd:element name="state" type = "xsd:string"/ >
                <xsd:element name="dateLaMu" type = "xsd:dateTime"/ >
                <xsd:element name="userbaMu" type = "xsd:string"/ >
                <xsd:element name="language" type = "xsd:string"
minOccurs - "0"/ >
                <xsd:element name="category" type "xsd:string"
minOccurs = "0"/ >
                <xsd:element name="helpInfo" type = "xsd:string"
minOccurs = "0"/ >
                <xsd:element name="valueList" type « "xsd:string"
minOccurs • "0"/ >
                <xsd:element name="userDefinedType" >
                    <xsd:complexType>
                        <xsd:choice>
                            <xsd:element ref="iso29481p2a:UserDefinedType"/ >
                            <xsd:element ref="iso29481p2a:UserDefinedTypeRef"/ >
                        </xsd:choice>
                    </xsd:complexType>
                </xsd:element>
            </xsd:sequence>
        </xsd:extension>
    </xsd:complexContent>
</xsd:complexType>
<xsd:complexType name="TransactionPhaseType" >
    <xsd:complexContent>
        <xsd:extension base« "iso29481p2a:elementType" >
            <xsd:sequence>
                <xsd:element name="description" type • "xsd:string"/ >
                <xsd:element name="startDate" type = "xsd:dateTime"/ >
                <xsd:element name="endDate" type = "xsd:dateTime"/ >
                <xsd:element name="state" type = "xsd:string"/ >
                <xsd:element name="dateLaMu" type = "xsd:dateTime"/ >
                <xsd:element name="userbaMu" type = "xsd:string"/ >
                <xsd:element name="language" type = "xsd:string"
minOccurs "0"/ >
                <xsd:element name="category" type "xsd:string"
minOccurs "0"/ >
                <xsd:element name="helpInfo" type = "xsd:string"
minOccurs "0"7 >
                <xsd:element name="code" type = "xsd:string"
minOccurs "0"7 >

```

```

    </xsd:sequence>
  </xsd:extension>
</xsd:complexContent>
</xsd:complexType>
<xsd:complexType name="TransactionType" >
  <xsd:complexContent>
    <xsd:extension base="iso29481p2a:elementType" >
      <xsd:sequence>
        <xsd:element name="description" type="xsd:string"/ >
        <xsd:element name="startDate" type="xsd:dateTime"/ >
        <xsd:element name="endDate" type="xsd:dateTime"/ >
        <xsd:element name="state" type="xsd:string"/ >
        <xsd:element name="dateLaMu" type="xsd:dateTime"/ >
        <xsd:element name="userLaMu" type="xsd:string"/ >
        <xsd:element name="language" type="xsd:string"/ >
        <xsd:element name="category" type="xsd:string"/ >
        <xsd:element name="helpInfo" type="xsd:string"/ >
        <xsd:element name="code" type="xsd:string"/ >
        <xsd:element name="result" type="xsd:string"/ >
        <xsd:element name="subTransactions" minOccurs="0" >
          <xsd:complexType>
            <xsd:choice maxOccurs="unbounded" >
              <xsd:element ref="iso29481p2a:TransactionType"/ >
              <xsd:element ref="iso29481p2a:TransactionTypeRef"/ >
            </xsd:choice>
          </xsd:complexType>
        </xsd:element>
        <xsd:element name="initiator" >
          <xsd:complexType>
            <xsd:choice>
              <xsd:element ref="iso29481p2a:RoleType"/ >
              <xsd:element ref="iso29481p2a:RoleTypeRef"/ >
            </xsd:choice>
          </xsd:complexType>
        </xsd:element>
        <xsd:element name="executor" >
          <xsd:complexType>
            <xsd:choice>
              <xsd:element ref="iso29481p2a:RoleType"/ >
              <xsd:element ref="iso29481p2a:RoleTypeRef"/ >
            </xsd:choice>
          </xsd:complexType>
        </xsd:element>
        <xsd:element name="appendixTypes" minOccurs="0" >
          <xsd:complexType>
            <xsd:choice maxOccurs="unbounded" >
              <xsd:element ref="iso29481p2a:AppendixType"/ >
              <xsd:element ref="iso29481p2a:AppendixTypeRef"/ >
            </xsd:choice>
          </xsd:complexType>
        </xsd:element>
      </xsd:sequence>
    </xsd:extension>
  </xsd:complexContent>
</xsd:complexType>

```

```

        </xsd:choice>
      </xsd:complexType>
    </xsd:element>
  </xsd:sequence>
</xsd:extension>
</xsd:complexContent>
</xsd:complexType>
<xsd:complexType name="UserDefinedTypeType" >
  <xsd:complexContent>
    <xsd:extension base="iso29481p2a:elementType" >
      <xsd:sequence>
        <xsd:element name="description" type="xsd:string"/ >
        <xsd:element name="state" type="xsd:string"/ >
        <xsd:element name="dateLaMu" type="xsd:dateTime"/ >
        <xsd:element name="userLaMu" type="xsd:string"/ >
        <xsd:element name="baseType" type="xsd:string"/ >
        <xsd:element name="xsdRestriction" type="xsd:string"
minOccurs="0"/ >
        <xsd:element name="language" type="xsd:string"
minOccurs="0"/ >
        <xsd:element name="helpInfo" type="xsd:string"
minOccurs="0"/ >
      </xsd:sequence>
    </xsd:extension>
  </xsd:complexContent>
</xsd:complexType>
<!-- ( ENTITY ) -->
<xsd:complexType name="AppendixTypeTypeRef" >
  <xsd:complexContent>
    <xsd:extension base="iso29481p2a:elementTypeRef"/ >
  </xsd:complexContent>
</xsd:complexType>
<xsd:complexType name="ComplexElementTypeTypeRef" >
  <xsd:complexContent>
    <xsd:extension base="iso29481p2a:elementTypeRef"/ >
  </xsd:complexContent>
</xsd:complexType>
<xsd:complexType name="ElementConditionTypeRef" >
  <xsd:complexContent>
    <xsd:extension base="iso29481p2a:elementTypeRef"/ >
  </xsd:complexContent>
</xsd:complexType>
<xsd:complexType name="GroupTypeTypeRef" >
  <xsd:complexContent>
    <xsd:extension base="iso29481p2a:elementTypeRef"/ >
  </xsd:complexContent>
</xsd:complexType>
<xsd:complexType name="MessageInTransactionTypeTypeRef" >
  <xsd:complexContent>
    <xsd:extension base="iso29481p2a:elementTypeRef"/ >
  </xsd:complexContent>
</xsd:complexType>
<xsd:complexType name="MessageTypeTypeRef" >

```

```

    <xsd:complexContent>
      <xsd:extension base="iso29481p2a:elementTypeRef"/>
    </xsd:complexContent>
  </xsd:complexType>
<xsd:complexType name="OrganisationTypeTypeRef" >
  <xsd:complexContent>
    <xsd:extension base="iso29481p2a:elementTypeRef"/>
  </xsd:complexContent>
</xsd:complexType>
<xsd:complexType name="PersonTypeTypeRef" >
  <xsd:complexContent>
    <xsd:extension base="iso29481p2a:elementTypeRef"/>
  </xsd:complexContent>
</xsd:complexType>
<xsd:complexType name="ProjectTypeTypeRef" >
  <xsd:complexContent>
    <xsd:extension base="iso29401p2a:elementTypeRef"/>
  </xsd:complexContent>
</xsd:complexType>
<xsd:complexType name="RoleTypeTypeRef" >
  <xsd:complexContent>
    <xsd:extension base="iso29481p2a:elementTypeRef"/>
  </xsd:complexContent>
</xsd:complexType>
<xsd:complexType name="SimpleElementTypeTypeRef" >
  <xsd:complexContent>
    <xsd:extension base="iso29481p2a:elementTypeRef"/>
  </xsd:complexContent>
</xsd:complexType>
<xsd:complexType name="TransactionPhaseTypeTypeRef" >
  <xsd:complexContent>
    <xsd:extension base="iso29401p2a:elementTypeRef"/>
  </xsd:complexContent>
</xsd:complexType>
<xsd:complexType name="TransactionTypeTypeRef" >
  <xsd:complexContent>
    <xsd:extension base="iso29481p2a:elementTypeRef"/>
  </xsd:complexContent>
</xsd:complexType>
<xsd:complexType name="UserDefinedTypeTypeRef" >
  <xsd:complexContent>
    <xsd:extension base="iso29481p2a:elementTypeRef"/>
  </xsd:complexContent>
</xsd:complexType>
<!-- ( SELECT ) -->
<!-- { ENUMERATION } -->
<!-- ( TYPE ) -->
<!-- , elementType, simpleType, logical ( ) -->
<xsd:complexType name="elementType" >
  <xsd:attribute name="id" type="xsd:ID" use="required"/>

```

```

</xsd:complexType>
<xsd:complexType name="elementTypeRef" >
  <xsd:attribute name="idref" type="xsd:IDREF" use="required"/ >
</xsd:complexType>
<xsd:simpleType name="logical" >
  <xsd:restriction base="xsd:string" >
    <xsd:enumeration value="true"/ >
    <xsd:enumeration value="false"/ >
    <xsd:enumeration value="unknown"/ >
  </xsd:restriction >
</xsd:simpleType>
</xsd:schema>

```

A.4

A.4.1 AppendixType

: id  
 : description, startDate, endDate, state, dateLaMu, userLaMu, language, category, helpinfo, code  
 : complexElements

AppendixType

```

<AppendixType id="StandardAppendixType" >
  <description>CTaHaapTHboi npwno»:eHMn</description>
  <startDate>2007-01-23T00:00:00Z</startDate>
  <endDate>2007-12-31T00:00:00Z</endDate>
  <state>active</state>
  <dateLaMu>2007-01-23T00:00:00Z</dateLaMu>
  <userLaMu>bapa</userLaMu>
</AppendixType>

```

— appendixTypes. Ecm

.4.2 ComplexElement Type

: id  
 : description, startDate, endDate, state, dateLaMu, userLaMu, language, category, helpinfo  
 : elements

ComplexElement Type                      SimpleElement Types.                      SimpleElement Type

```

«ComplexElement Type id="Henultera" >
  <description > */description >
  <startDate>2007-01-23T00:00:00Z</startDate>
  <endDate>2007-12-31T00:00:00Z</endDate>
  <state>active</state>
  <dateLaMu>2007-01-23T00:00:00Z</dateLaMu>
  <userLaMu>bapa</userLaMu>
  «elements?
    «SimpleElement TypeRef        idref="Name"/ >
    «SimpleElement TypeRef        1 ~" 1 *7 >
    «SimpleElement TypeRef        idref="Description"/ >
    «SimpleElement TypeRef        idref="Calorie3"/ >
  «/elements?
</ComplexElement Type>

```



## .4.3 ElementCondition

```

; id
: description. requiredNotify. minValue, maxValue, format, helpinfo
: message, element
SimpleElementType, MessageType.

```

```

<ElementCondition id="Price restriction" >
  <description 1 > & uenKX/description>
  <requiredNotify>D</requiredNotify>
  <minValue>5.00</minValue>
  <element>
    <SimpleElementType>UeH</SimpleElement>
  </element>
  <message>
    <MessageTypeRef idref="ProvideWithMenuMessage" / >
  </message>
</ElementCondition>

```

## A.4.4 GroupType

```

; id
: description, startDate. endDate. state. dateLaMu. userLaMu. language, category, helpinfo.

```

```

<GroupType id="StandardGroupType" >
  <description 1 > ? rpyna</description>
  <startDate>2007-12-20T00:00:00Z</startDate>
  <endDate>2008-12-31T00:00:00Z</endDate>
  <state>active</state>
  <dateLaMu>2007-12-20T00:00:00Z</dateLaMu>
  <userLaMu>bapa</userLaMu>
</GroupType>

```

## A.4.5 MessageType

```

; id
, description, startDate. endDate. state. dateLaMu. userLaMu. language, category, helpinfo, code
: complexElements. appendixTypes
(MessageType),
SimpleElementType ( ComplexElementType)

```

```

< id="ProvideWithMenuMessage" >
  <description>Coo6eaeHKej .</description>
  <startDate>2008-01-23T00:00:00Z</startDate>
  <endDate>2008-12-31T00:00:00Z</endDate>
  <state>active</state>
  <dateLaMu>2008-01-23T00:00:00Z</dateLaMu>
  <userLaMu>bapa</userLaMu>
  <complexElements>
    <ComplexElementRef idref="Item" / >
  </complexElements>
  <appendixTypes>
    <AppendixTypeRef idref="MenuCard" / >
  </appendixTypes>
</MessageType>

```

```

firstMessage.

```

8

## .4.6 MessageInTransactionType

```

; id
: requiredNotify. dateLaMu. userLaMu. received, send, state. initiatorToExecutor. openSecondaryTransactionsAllowed. firstMessage

```

: message, previous. transaction. transactionPhase. group, appendix Types  
 MessageType 8 TransactionType. (GroupType).

```

«MessageInTransactionType id="MiTT_002*" >
  <requiredNotify>0</requiredNotify>
  <dateLaMu>2008-01-23T00:00:00Z</dateLaMu>
  «userLaMu»bapa</userLaMu>
  <received>true</received>
  <send>true</send>
  <state>active</state>
  <initiatorToExecutor>false</InitiatorToExecutor>
  <openSecondaryTransactionsAllowed>true</openSecondaryTransactionsAllowed>
  <firstMessage>tdlee</firstMessage>
  «message»
    «MessageTypeRef idref="ProvideWith"enuMessage~/ >
  «/message»
  «previous»
    <MessageInTransactionTypeRef idref="MiTT_001"/ >
  «/previous»
  «transaction»
    «TransactionTypeRef idref="ObtainMenuTransaction*/ >
  «/transaction»
  «transactionPhase»
    «TransactionPhaseTypeRef idref="MenuDelivered~ >
  «/transactionPhase»
  «group»
    «GroupTypeRef idref="StandardGroupType"/ >
  «/group»
  «appendixTypes»
    «AppendixTypeRef idref="MenuCard*/ >
  «/appendixTypes»
«/MessageInTransactionType»
    
```

**A.4.7 OrganisationType**

: td  
 : description. startDate. endDate. state. dateLaMu. userLaMu. language, category, helpinfo. code  
 : complexElements

```

«OrganisationType id="StandardOrganisationType" >
  «description1 » opi-aKH3auHH</description>
  <startDate>2008-01-23T00:00:00Z</startDate>
  «endDate»2008-12-31T00:00:00Z</endDate>
  <state>active</state>
  <dateLaMu>2008-01-23T00:00:00Z</dateLaMu>
  <userLaMu»bapa</userLaMu>
«/OrganisationType»
    
```

**A.4.8 PersonType**

: id  
 : description. startDate. endDate. state. dateLaMu. userLaMu. language, category, helpinfo, code  
 : complexElements

```

«PersonType id="StandardPersonType" >
  «description»CTaiutapTKMR Anua</description>
  <startDate>2008-01-23T00:00:00Z</startDate>
  <endDate>2008-12-31T00:00:00Z</endDate>
  <state>active</state>
    
```

```

«dateLaMu?2008-01-23T00:00:00Z»/dateLaMu?
«userLaMu?bapa»/userLaMu?
«/PersonType?

```

#### A.4.9 ProjectType

```

: id
: namespace, description, startDate, endDate, state, dateLaMu, userLaMu, language, category, helpInfo, code
: complexElements

```

```

«ProjectType id="StandardProjectType" >
<namespace?http://www.iso29421-2.com/testproject»/namespace>
«description?ProjectType description?
<startDate?2008-01-23T00:00:00Z»/startDate>
<endDate?2008-12-31T00:00:00Z»/endDate>
<state>active</state>
<dateLaMu?2008-01-23T00:00:00Z»/dateLaMu>
<userLaMu?bapa»/userLaMu>
«/ProjectType?

```

#### A.4.10 RoleType

```

: id
: description, startDate, endDate, state, dateLaMu, userLaMu, language, category, helpInfo, code,
responsibilityFeedback, responsibilityScope, responsibilitySupportTask, responsibilityTask

```

```

«RoleType id="walter" >
<description?ProjectType description?
<startDate?2008-05-04T00:00:00Z»/startDate>
<endDate?2008-05-04T00:00:00Z»/endDate>
<state>active</state>
<dateLaMu?2008-05-04T00:00:00Z»/dateLaMu>
«userLaMu?MMA»/userLaMu?
«language/?
«category/?
«helpInfo/?
«code/?
«responsibilityScope/?
«responsibilityTask/?
«responsibilitySupportTask/?
«responsibilityFeedback/?
«/RoleType?

```

#### A.4.11 SimpleElementType

```

: id
: description, interfaceType, state, dateLaMu, userLaMu, language, category, helpInfo, valueUst
: composedOf userDefinedType
(SimpleElementType).
HanpuMessage (AppendixType, ProjectType,
PersonType, OrganisationType), SimpleElementType, ComplexElementType.

```

```

«SimpleElementType id="Kame" >
<description?ProjectType description?
«interfaceType/?
<state>active</state>
«dateLaMu?2008-01-23T00:00:00Z»/dateLaMu?
<userLaMu?bapa»/userLaMu?
«userDefinedType?
«UserDefinedTypeRef idref="String"/?
«/UserDefinedType?
«/SimpleElementType?

```

.4.12 TransactionPhaseType

, id  
 : description. startDate. endDate. state. dateLaMu, userLaMu. language, category, helpinfo, code  
 The definition of a phase related to a transaction. : « » « ».

«TransactionPhaseType id="WaitingForMenu" \*  
 «descrip 1 \* 4ocra&neHO</description\*  
 <startDate\*2008-01-23T00:00:00Z</startDate\*  
 <endDate\*2008-12-31T00:00:00Z</endDate\*  
 <state\*active</state\*  
 <dateLaMu>2008-01-23T00:00:00Z</dateLaMu>  
 <userLaMu>bapa</userLaMu>  
 </TransactionPhaseType\*»

A.4.13 TransactionType

: id  
 : description. startDate. endDate. state. dateLaMu. userLaMu, language, category, helpinfo. code, result  
 : initiator, executor, subTransactions

«TransactionType id="MenuObtainingTransaction" \* >  
 «descrip 1 \* </ 1 1 1 \*  
 <startDate>2008-01-23T00:00:00Z</startDate\*  
 <endDate\*2008-12-31T00:00:00Z</endDate\*  
 <state\*active</state\*  
 <dateLaMu\*2008-01-23T00:00:00Z</dateLaMu\*  
 <userLaMu\*bapa</userLaMu\*  
 «initiator\*  
 «RoleTypeRef id="role" \*/ >  
 </initiator\*  
 «executor\*  
 «RoleTypeRef id="role" \*/ \*  
 </executor\*  
 </TransactionType\*»

A.4.14 UserDefinedType

: #id  
 : description, state. dateLaMu. userLaMu. baseType. xsdRestriction. language, helpinfo  
 ( SimpleElementType).

«UserDefinedType id="String" \* >  
 «descrip 1 1 \* CTpoxa</description\*  
 <state\*active</state\*  
 <dateLaMu\*2001-12-20T00:00:00Z</dateLaMu\*  
 <userLaMu\*bapa</userLaMu\*  
 <baseType\*STRING</baseType\*  
 «xsdRestriction/\*  
 </UserDefinedType\*»

A.5

A.5.1 id

«OrganisationType id="TNO Building and Construction" \*  
 «descrip 1 1 > </ 1 1 1 \*  
 <startDate>2007-12-12T00:00:00Z</startDate\*  
 <endDate\*9999-12-31T00:00:00Z</endDate\*»

```

<stdte>active</state>
<dateLaMu>2007-12-12T00:00:00Z</dateLaKu>
<userLaMu>test(OAnage(nent</userLaMu>
<ienguage>NL</languages
ccacegory>S</category>
<helpInfoshttp://.../</help!nfo>
<code>DEFAULT</codes

```

</OrganisatlonTypes

Message object

«nawesTNO Building & Construction</naoe>

<statesactive</state>

<dateLaMu>2007-12-02T00:00:00Z</dateLaMu>

<userLaMuSFecer Bonsna</userLaKu>

«/organisations

A.6

A.6.1 baseType

SimpleElementType.

<SiwpieEieraentrype id-"Height" >

cusec DeiinedT ype >

«UserDetinedType id-"..." >

< bas eTypesINTEGER\*/bas eTypes

«/UserDefi.nedTypes

«/User DeiinedTypes

c/SimpleBiementTypes

*Height* SimpleEtementType ( , ;  
xsdRestriction).

.6.2 category

.6.3 code ( ).

<... id-".. ." >

33156

</...>

.6.4 dateLaMu

<... id-"..." >

<dateLaMu>2007-12-02T00:00:00Z</dateLaMu>

</...>

A.6.5 description

«... id« "Ooorleat" >

«descriptionsCeaoptca .«/descriptions

</...>

.6.6 endDate

<... id-"..." >

<endOate\*2007-02-03T00:00:C>0Z</en<IDate>

</...\*

.6.7 firstMessage

MessageInTransactionType

— false.

«HessageInTransactionType id-"..." >

«firs tMessage>true</first Message\*

«/MessageInTransactionType\*

A.6.8 format

( ).

A.6.9 helpinfo

URL- URI-

«... id-".">

«helpInfo\*http://www.ISO 29481\_Part\_2A.com/helpInfo\_obJect0001.html «/helpInfo\*

</...>

A.6.10 initiatorToExecutor

«HessageInTransactionType id-"..." >

<initiatorToExecutor\*false«/initiatorToExecutor\*

«message\*

«MessageType id-"\*TenderAcceptance" >

«/MessageType\*

«/message\*

«transaction\*

«TransactionType Id-^TenderTraject" \*

«initiator\*

«RoleType id-"Per£ormer" >

«/RoleType\*

«/initiator\*

«executor\*

«RoleType id-"Client" \*

«/RoleType\*

«/executor\*

«/TransactionType\*

«/transaction\*

«HessageInTransactionType id-"..." \*

( , TenderAcceptance ( ) )

.6.11 interfaceType

SimpleElementType

.6.12 language

<... id-".>

<language>NL</language>

</...>

.6.13 namespace

<ProjectType id-". " ?

<namespace>http://www.visi.nl/teatraamxer!«/namespace>

</ProjectType>

namespace.

.6.14 openSecondaryTransactionsAllowed

( OR). FALSE ( AND). TRUE openSecondaryTransactionsAllowed TRUE.

.6.15 received

.6.16 requiredNotify

.6.17 responsibilityFeedback

.6.18 responsibilityscope

.6.19 responsibilitySupportTask

.6.20 responsibilityTask

.6.21 result

A.6.22send

.6.23 startDate

<... id-".>

<StartDate>2007-02-03T00:00:00</startDate>

</...>

.6.24 state

<... id-". " >

<state>active</state>

</...>

<... id="..." >

<state>passive</state>

</...>

.6.25 userLaMu

<... id="..." >

<userLdMu>Peter Bonsma</userLaMu>

</...>

.6.26 valueList

« UserDefviedType xsdResIncbon. 8 xsdRestriction.

<SimpleElementType id="..." >

<valueList>Groen;Rood;Oker GeeK/valueList</valueList>

</SimpleElementType>

A.6.27 xsdRestriction

SimpleElementype UserDefinedType.

.7

.7.1 appendixTypes

.7.2 complexElements

SimpleElecnentType { a ComplexElementType).

<... Id='Abc' >

«complexElements»

<CoaplexEleo>entType Id="Elew>entsSet1\* >

«elements»

«SimpleElementType id-"Element\_A" >

</SimpleElementType>

«SimpleElementType id-"Element\_B" >

</SimpleElementType>

</elements>

</ComplexElementType>

«ComplexElementType id-"ElementsSet2" >

</ComplexElementType>

«ComplexElementType id-"ELementsSet3" >



```

    «/ComplexElementType»
  «/complexElements»
«/...»

```

:

«Abe id-">

```

«elementsSet1»
  «ElementsSet1»
    <Element_A>...</Element_A>
    <Element_B>...</Element_B>
  «/ElementsSet1»

  «ElementsSet1»
    <Element_A>...</Element_A>
    <Element_B>...</Element_B>
  «/ElementsSet1»
«/elementsSet1»
«elementsSet2»
  «ElementsSet2»

  </ElementsSet2>

  <ElementsSet2»

  «/ElementsSet2»
«/elementsSet2»
«elementsSet3»
  <ElementsSet3>

  «/ElementsSet3»

  <ElementsSet3>

  </ElementsSet3>
«/elementsSet3»
«/...»

```

A.7.3 composedOf

SimpleElementType  
ComplexElementType).

SimpleElementType (

«SimpleElementType id-"Doorleaf" »

```

«composedOf»
  «ComplexElementType id^'Measurement" >

    «elements»
      «SimpleElementType id~Hei<jht~ »

      «/SimpleElementType»
      «SimpleElementType id^Width* »

      «/SimpleElementType»
      «SimpleElementType id«Thickness" »

      «/SimpleElementType»
    «/elements»
  «/ComplexElementType»
  «ComplexElementType id~"Material-selection" »

```

```

«elements»
  «SimpleElementType id-"Type-of-wood" >
    «/SimpleElementType»
  «/elements»
«/ComplexElementType»
«/composedOC»
«/SimpleElementType»

```

:

«Doorleaf»

```

«Measurement id"_____ " >
  «Height»_____ «/Height»
  «Width»...«/Width»
  «Thickness»_____ «/Thickness»
«/Measurement»
«Material-selection id-"...*" »
  « -of-wood»...«/Type-of-wood»
«/Material-selection»
«/Doorleaf»

```

A.7.4 element

SimpleEtementType.

MessageType.

«Elementcondition id-"..." >

<minValue>2000«/minValue»

```

«element»
  «SimpleElementTypeRef idref-"Doorheight~" >
«/element»
«message»
  «MessageType id-"M~" >
    «complexEiements»
      «ComplexElemen tType»
    «elements»
      «SiapieElementType id-"Dooxheight" »
    «/SimpleElementType»
  «/elements»
«/ComplexElementType»
«/complexEiements»
«/MessageType»
«/message»
«/Elementcondition»

```

MessageType

Doorheight

2000.

.7.5 elements

SimpleEtementType.

SimpleEtementType.

ComplexEtemectlType.

«ComplexElementType id-"Door" >

```

«elements»
  «SimpleElementType id-"Doarleaf" »
  «/SimpleElementType»
  «SimpleElementType id-"Fastenings" »

```

```

    «/SimpleElementType*
    «SimpleElementType id-"UpperWindow" *
  «/SimpleElementType*
«/elements*
«/CocipiexEleoentType

```

:

```
«... id-"..." >
```

```

  «door*
    «Door*
      «OoorleaC*...«/Doorleaf*
      «Fastenings*...«/Fastenings*
      «UpperWindow*...«/UpperWindow*
    «/Door*

    «door*
      «Doorleaf*...«/Doorleaf*
      «Fastenings*...«/Fastenings*
      «UpperWindow*...«/UpperWindow*
    «/Door*
  «/door*
«/...*

```

#### A.7.6 executor

(RoleType).

```
«TransactionType id-"TenderTraject" *
```

```

  «executor*
    «RoleType id-"Client" >

  «/RoleType*
«/executor*

```

```
«/TransactionType*
```

#### A.7.7 group GroupType.

```
«MessageZnTransactionType id-"_____ " >
```

```

  «message*
    «_____ id-"M" >

    «/_____ *
  «/message*
  «group*
    «GroupType id-"G" >

    «/GroupType*
  «/group*
  «transaction*
    «TransactionType id-"T" *

  «/TransactionType*
«/transaction*

```

```
«/MessageInTransactionType*
```

G ( )

.7.8 Initiator (RoleType).

«TransactionType id»"TenderTraject" >

«initiator?  
«RoleType Id-"Performer" ?

«/RoleType?  
«/initiator?

«/ ra nsacti >

A.7.9 message  
MessageInTransadionType.

«MessageTnTransactionType id»"\_\_\_\_\_ " >

«message?  
«MessageType id-" \_\_\_\_\_ " ?

«/MessageType?  
«/message?

«/MessageInTransactionType

A.7.10 previous  
MessageInTransadionType  
( MessageInTransadionType  
TransactionType).

«MessageInTransactionType id»H...H >

«previous?  
«MessageInTransactionType id»"..." ?

«message?  
«MessageType id»"Tender" >

«/MessageType?  
«/message?

«/MessageInTransactionType?  
«/previous?

«message?  
«MessageType id»"TenderAcceptance" ?

«/MessageType?  
«/message?

</MessageinTransactionType?8ubTransactions

«TransactionType id»"AcquireWork" ?

«eubTransactions?  
«TransactionType id»"AcquisitionTrack" ?

```

</TransactionType>
«TransactionType Id="TenderTrack" >

</TransactionType>
</subTransactions>
</TransactionType>

TnoTransacbonType co      AcquireWorkcoctovn      co      AcquisibonTrack
TemferTraject.
A.7.11 simpleElements

```

```

«ComplexElementType id="Door" >

```

```

<simpleElements>
  «SimpleElementType id="Doorleaf" >

  </SimpleElementType>
  «SimpleElementType id="HingesAndLocks" >

  </SimpleElementtype>
  «SimpleElementType id="UpperWindow" >

  </SimpleElementtype>
</simpleElements>
</ComplexElementtype>

```

```

... id="..." >

```

```

<door>
  <Door>
    «DoorleaO...«/DoorleaO
    « HingesAndLocks >...«/ HingesAndLocks >
    < Upperwindow >...«/ Upperwindow >
  </Door>

  <Door>
    < Doorleat >...«? Doorleat >
    « HingesAndLocks >...«/ HingesAndLocks >
    < Upperwindow >...«/ UpperWindow >
  </Door>
</door>
</...>

```

A.7.12 subTransactions

```

«TransactionType Id="AcquisitionO&Work" >

<subTransactions>
  «TransactionType id="AcquisitionTraject*" >

  «/TransactionType»
  «TransactionType Id="TenderTraject" >

  «/TransactionType»
</subTransactions>
</TransactionType»

```

.7.13 transaction

MessageinTransactionType.

—  
«MessageinTransactionType id» "... " »

«transaction»  
«TransactionType id»\*..." >  
«/TransactionType»  
«/transaction»

«/MessageinTransactionType»

A.7.14 transactionPhase  
TransactionPhase

MessageType

TransactionType.

—  
«MessageinTransactionType id» "... " >

«message»  
«MessageType id-" " " >  
«/MessageType»  
«/message»  
«transaction»  
«TransactionType id»"T" »  
«/TransactionType»  
«/transaction»  
«transactionPhase»  
«TransaccionPhaseType id»"TP" »  
«/TransactionPhaeetype»  
«/transactionPhase»

«/MessageinTransactionType»

MessageType.  
TransactionPhaseType.

M

TransactionType.

.7.15 userDefinedType

UserDefinedType.

SimpleElementType.

—  
«SimpleElementype id» "Height" »

«userDefinedType»  
«UserDefinedType id» "... " >  
«baseType» iHTEGERc/baseType»  
«/UserDefinedType»  
«/UserDefinedType»  
«/SimpleElementType»

SimpleElementType Height  
xsdRestriction).

Integer

( ,

( )

.1

EXPRESS.

.2

1\*

SCHEMA ISO 29481\_Part\_2B;  
 ENTITY GroupTemplate:  
 name: STRING;  
 description: STRING;  
 creationDate: DATETIME;  
 startDate: DATETIME;  
 endDate: DATETIME;  
 state: STRING;  
 dateLaMu: DATETIME;  
 userLaMu: STRING;  
 versionNo: STRING;  
 transaction: Transaction Template:  
 END. ENTITY;  
 ENTITY AppendixGroup;  
 state: STRING;  
 dateLaMu: DATETIME;  
 userLaMu: STRING;  
 group: GroupTemplate:  
 END. ENTITY;  
 ENTITY AppendixTemplate;  
 name: STRING;  
 fileLocation: STRING;  
 fileType: STRING;  
 fileVersion: STRING;  
 documentIdentification; STRING;  
 documentVersion; STRING;  
 documentReference: STRING;  
 objectCode: OPTIONAL STRING;  
 startDate: DATETIME;  
 endDate: DATETIME;  
 state: STRING;  
 dateLaMu: DATETIME;  
 userLaMu: STRING;  
 language: OPTIONAL STRING;  
 message: MessageTemplate:  
 appendixGroup: AppendixGroup;  
 template: ComplexElementTemplate:  
 END.ENTITY;  
 ENTITY MessageTemplate:  
 identification: STRING;  
 dateSend: DATETIME;  
 dateRead: DATETIME;  
 state: STRING;  
 dateLaMu: DATETIME;  
 userLaMu: STRING;  
 initiatingTransactionMessageID: OPTIONAL STRING;  
 initiatorToExecutor; BOOLEAN;

1&gt;

»,

29481-2.

messageInTransaction: MessageInTransactionTemplate;  
 transaction: TransactionTemplate.  
 template: ComplexElementTemplate;  
 END.ENTITY;  
 ENTITY MessageInTransactionTemplate;  
 identification: STRING;  
 dateSend: DATETIME;  
 dateRead: DATETIME;  
 state: STRING;  
 dateLaMu: DATETIME;  
 userLaMu: STRING;  
 END.ENTITY;  
 ENTITY TransactionTemplate;  
 number: INTEGER;  
 name: STRING;  
 description: STRING;  
 startDate: DATETIME;  
 endDate: DATETIME;  
 state: STRING;  
 dateLaMu: DATETIME;  
 userLaMu: STRING;  
 result OPTIONAL STRING;  
 initiator: PersonInRole;  
 executor: PersonInRole;  
 project: ProjectTypeInstance;  
 END.ENTITY;  
 ENTITY TransactionPhaseTemplate;  
 name: STRING;  
 description: STRING;  
 dateReached: DATETIME;  
 state: STRING;  
 dateLaMu: DATETIME;  
 userLaMu: STRING;  
 transaction: TransactionTemplate;  
 END\_ENTITY:  
 ENTITY PersonTemplate;  
 userName: STRING;  
 name: STRING;  
 state: STRING;  
 dateLaMu: DATETIME.  
 userLaMu: STRING;  
 template: ComplexElementTemplate;  
 END.ENTITY:  
 ENTITY OrganisationTemplate;  
 name: STRING;  
 abbreviation: STRING;  
 state: STRING;  
 dateLaMu: DATETIME;  
 userLaMu: STRING;  
 contactperson: PersonTemplate;  
 template: ComplexElementTemplate;  
 END.ENTITY:  
 ENTITY PersonInRole;  
 stale: STRING;  
 dateLaMu: DATETIME;  
 userLaMu: STRING;  
 successor: OPTIONAL PersonInRole;  
 substituting: OPTIONAL PersonInRole;  
 contactperson: PersonTemplate;  
 organization: OrganisationTemplate;  
 role: RoleTemplate;  
 END.ENTITY:



```

ENTITY RoleTemplate;
name: STRING;
description: STRING;
slate: STRING;
dateLaMu: DATETIME;
userLaMu: STRING;
category: OPTIONAL STRING;
END.ENTITY;
ENTITY ProjectTypeInstance;
name: STRING;
description: STRING;
startDate: DATETIME;
endDate: DATETIME;
state: STRING;
dateLaMu: DATETIME;
userLaMu: STRING;
template: ComplexElementTemplate;
END.ENTITY;
ENTITY ComplexElementTemplate;
template: SimpleElementVirtual;
END.ENTITY;
END.SCHEMA;

```

## 8.3

## B.3.1 AppendixGroup

```

: id
: state. dateLaMu. userLaMu
: group
n:m

```

```

— :
<AppendixGroup id="AppendixGroup_1" >
<state>act Lve</state?
<dateLaMu>2006-02-04T00:00:00Z</dateLaMu>
<userLaMu>bapa</userLaMu>
<group>
<StandardGroupType id="..." >
</StandardGroupType>
</group>
</AppendixGroup>

```

```

:
<GroupType id="StandardGroupType" >
cdescr 1 1. > rpyrna</description?
<startDate>2007-12-20T00:00:00Z</startDate>
<endDate>2007-12-31T00:00:00Z</endDate?
<state?active</state?
<dateLaMu>2007-12-20T00:00:00Z</dateLaMu?
<userLaMu?bapa</userLaMu?
</GroupType?

```

## 8.3.2 AppendixTemplate

```

: id
: name. fileLocation. fileType, fileVersion. documentIdentification. documentVersion. documentReference.
objectCode. startDate. endDate. slate. dateLaMu. userLaMu. language
: appendixGroup. message

```

```

— :
<Appendix id="ExampleDocument" >
<name?voorbeeld</name?
<fileLocation?\\srv-bouw\public\project\does\4Sword\fileLocation?

```

```

<fileType>application/msword</fileType>
<fileVersion>2007</fileVersion>
<documentIdentification>345899</documentIdentification>
<documentVersion>1</documentVersion>
<documentReference>FG783990</documentReference>
<startDate>2008-02-04T00:00:00Z</startDate>
<endDate>2008-12-31T00:00:00Z</endDate>
<state>active</state>
<dateLaMu>2008-02-04T00:00:00Z</dateLaMu>
<userLaMu>bapa</userLaMu>
<language>EN</language>
<appendixGroup>
  <AppendixGroup id="_____ " >
    </AppendixGroup>
  </AppendixGroup>
</Appendix>

```

```

<deception>CTaHsapTHOe (
  *description>
  <startDate>2008-02-04T00:00:00Z</startDate>
  <endDate>2008-12-31T00:00:00Z</endDate>
  <state>active</state>
  <dateLaMu>2008-02-04T00:00:00Z</dateLaMu>
  <userLaMu>bapa</userLaMu>
  <language>NL</language>
</AppendixType>

```

.3.3 ComplexElementTemplate

: id

.3.4 GroupTemplate

: id

: name, description, creationDate, startDate, endDate, state, dateLaMu, userLaMu, versionNo

: transaction

```

<StandardGroupType id="MenuBackgrounds" >
  <name>Menu Pictures</name>
  <description>Ha6op MeHD</description>
  <creationDate>2008-02-04T00:00:00Z</creationDate>
  <startDate>2008-02-04T00:00:00Z</startDate>
  <endDate>2008-12-31T00:00:00Z</endDate>
  <state></state>
  <dateLaMu>2008-02-04T00:00:00Z</dateLaMu>
  <userLaMu>bapa</userLaMu>
  <versionNo>1</versionNo>
  <transaction>
    <MenuObtainingTransaction id="_____ " >
      </MenuObtainingTransaction>
    </transaction>
  </StandardGroupType>

```

```

<GroupType id="StandardGroupType" >
  <description>rpynna</description>
  <startDate>2007-12-20T00:00:00Z</startDate>
  <endDate>2008-12-31T00:00:00Z</endDate>
  <state>active</state>
  <dateLaMu>2007-12-20T00:00:00Z</dateLaMu>
  <userLaMu>bapa</userLaMu>

```

```

«/GroupType»
«TransactionType id="MenuObtainIngTransaction" >
  «descr1 ^ ^ » /descr1otion»
  «startDate>2008-01-23T00:00:00Z</startDate>
  «endDate>2008-12-31T00:00:00Z</endDate>
  «state>active</state>
  «dateLaMu>2008-01-23T00:00:00Z</dateLaMu>
  «userLaMu>bapa</userLaMu>
  «initiator»
    «RoieTypeRef idref="Consumer"/ >
  «/initiator»
  «executor»
    «RoieTypeRef idref=""/ >
  «/executor»
«/TransactionType»

```

### 8.3.5 MessageInTransactionTemplate

```

: id
: identification. dateSend. dateRead. state. dateLaMu, userLaMu. initiatorToExecutor
MessageInTransactionType

```

### 0.3.6 Message Template

```

: id
: identification. dateSend. dateRead. state. dateLaMu. userLaMu, initiatingTransactionMessageID.
initiatorToExecutor
: transaction. messageInTransaction. template
MessageType.
Organisation Template ( ).

```

```

«HandOutOCMenuMessage id="a002- >
  <identification>id 002</identification>
  <dateSend>2008-01-23T00:00:00Z</dateSend>
  <dateRead>2008-01-23T00:00:00Z</dateRead>
  <state>active</state>
  <dateLaMu>2008-01-23T00:00:00Z</dateLaMu>
  <userLaMu>bapa</userLaMu>
  <initiatingTransactionMessageID>a009</initiatingTransactionMessageID>
  <initiatorToExecutor>false</initiatorToExecutor>
  «messageInTransaction»
    <MessageZnTransactionI2Ref idref="BIT001"/ >
  «/messageInTransaction»
  «transaction»
    «MenuObtainingTransaction id="_____ " »
  «/MenuObtainingTransaction»
«/transaction»
«menu»
  «Menu id-"..." »
  «/Menu»
  «Menu id-"..." »
  «/Menu»
«/menu»
«/HandOutOCMenuMessage»

```

```

«TransactionType id="MenuObtainingTransaction" >
  «description» TpaHsaKuuA /description»
  «startbate>2008-01-23T00:00:00Z</startOate>

```

```

</endDate>2008-12-31T00:00:00Z</endDate>
<state>active</state>
<dateLaMu>2008-01-23T00:00:00Z</dateLaMu>
<userLaMu>bapa</userLaMu>
<initiator>
  «RoieTypeRef idref="Consumer"/ >
</initiator>
<executor>
  «RoieTypeRef idref=" " / >
</executor>
</TransactionType>
<MessageType id="HandOutOfMenuMessage" >
  <description>Coo6tueHue</description>
  <startDate>2008-01-23T00:00:00Z</startDate>
  <endDate>2008-12-31T00:00:00Z</endDate>
  <state>active</state>
  <dateLaMu>2008-01-23T00:00:00Z</dateLaMu>
  <userLaMu>bapa</userLaMu>
  <complexElements>
    «ComplexElementTypeRef idref="Menu" / >
  </complexElements>
</MessageType>
<ComplexElementType id="Menu" >
  <description>flocTynHbie</description>
  <startDate>2008-01-23T00:00:00Z</startDate>
  <endDate>2008-12-31T00:00:00Z</endDate>
  <state>active</state>
  <dateLaMu>2008-01-23T00:00:00Z</dateLaMu>
  <userLaMu>bapa</userLaMu>
  <elements>
    «SimpleElementTypeRef idref="MenuItems" / >
  </elements>
</ComplexElementType>

```

B.3.7 OrganisationTemplate

```

, id
: name, abbreviation, state, dateLaMu, userLaMu
: contactPerson, template
( ),
Transaction Template
:
<StandardOrganisationType id="TNO" >
  <name>Netherlands organisation for Applied Scientific Research</name>
  <abbreviation>TNO</abbreviation>
  <state>active</state>
  <dateLaMu>2008-01-23T00:00:00Z</dateLaMu>
  <userLaMu>bapa</userLaMu>
  <contactPerson>
    «StandardPersonType id=" " >
  </StandardPersonType>
</contactPerson>
</StandardOrganisationType>
:
<PersonType id="StandardPersonType" >
  <description>npouecca</description>
  <startDate>2008-01-23T00:00:00Z</startDate>
  <endDate>2008-12-31T00:00:00Z</endDate>
  <state>active</state>
  <dateLaMu>2008-01-23T00:00:00Z</dateLaMu>

```

```

    «userLaMu>bapa</userLaMu>
  </PersonType?
«OrganisationType id'^tandardOrganisationType" ?
  «description?THn /description?
  «startDate>200B-01-23T00:00:00Z</startDate?
  «endDate>2008-12-31T00:00:00Z</endDate?
  <state>active</state>
  «dateLaMu?2008-01-23T00:0D:00Z</dateLaKu?
  «userLaMu?bapa</userLaMu>
</OrganisationType?

```

### B.3.8 PersonInRole

```

  : id
  : stale. dateLaMu, usertaMu
  : organization, contactPerson. role, substituting, successor

```

```

«PersonInRole id-^ JohnAsCustower" >
  <state?active</state?
  «dateLaMu?2DOB-01-23TOO:00:00Z</dateLaMu>
  «userLaMu>bapa</userLaMu>
  «contactperson?
    «StandardPersonType id»"..." ?

    «/StandardPersonType?
  </con tact Pe r son >
  «organisation?
    «StandardOrganisationType id»"..." >

    «/StandardOrganisationType?
  </organisation?
  «role?
    «Consumer idref»"..." >

    «/Consumer?
  </role?
</PersonInRole?

```

```

«PersonType id»"StandardPersonType" ?
  «descr1 1 ? npouecca</description?
  «startDate>200B-OI-23T00:00:00Z</startDate?
  «endDate>200B-12-31T00:00:00Z</endDate?
  «state?active</state?
  «dateLaMu?2008-01-23T00:0D:00Z</dateLaKu?
  «userLaMu?bapa</userLaMu?
</PersonType?
«OrganisationType id'^StandardOrganisationType" ?
  «description?Tun /description?
  «startDate>200B-01-23T00:00:00Z</starLD8te?
  <endDate?2006-12-31T00:00:00Zt/endDate?
  <state?active</state?
  «dateLaMu?2008-01-23T00:00:00Z</dateLaMu>
  <userLaMu?bapa</userLaMu?
</OrganisationType?
«RoleType id-^Consumer" ?
  «description>noTpeOMTe/ib</description?
  «startOate>200B-01-23T00:00:00Z</startDate?
  «endDate?2008-12-31T00:00:00Z</endDate?
  <state>active</state>

```

```
<dateLaMu>2008-01-23 00:00:00Z</dateLaMu>
<userLaMu>bapa</userLaMu>
</RoleType>
```

.3.9 PersonTemplate

```
: id
: userName. name, state. dateLaMu. userLaMu
```

```
(StandardPersonType £d-"PBonstnA' >
<userName>bapa</userName>
<name>Peter Bonsma</name>
<state>active</state>
<dateLaMu>2008-02-04T00:00:00Z</dateLaMu>
<userLaMu>bapa</userLaMu>
«/StandardPersonType»
```

```
(PersonType id*)"rStandaxdPersonType*r" >
<description>Tn.n npouecca</description>
<StartDate>2008-01-23T00:00:00Z</startDate>
<endDate>2008-12-31T00:00:00Z</endDate>
<state>active</state>
<dateLaMu>2008-01-23T00:00:00Z</dateLaMu>
«userLaHu»bapa</userLaHu»
«/PersonType»
```

B.3.10 ProjectTemplate

```
: id
: name, description. slartDate. endDate. state. dateLaMu. userLaMu
```

```
«StandardProjectType Ld»*ICM2* >
<name>The project IDM2</name>
«description» > « IDM2</description>
<startDate>2008-02-04T00:00:00Z</startDate>
«endDate>2008-12-31T00:00:00Z</endDate>
<state>active</state>
<dateLaMu>2008-02-04T00:00:00Z</dateLaMu>
<userLaMu>bapa</userLaMu»
«/StandardProjectType»
```

```
<ProjectType id>"StandaxdPxojectType" >
<description>Tnn npoeKTA</description>
<startDate>2008-02-04T00:00:00Z</startDate>
<endDate>2008-12-31T00:00:00Z</endDate>
<state>active</state>
«dateLaMu»2008-02-04T00:00:00Z</dateLaMu»
<userLaMu>bapa</userLaMu»
«/ProjectType»
```

B.3.11 RoleTemplate

```
: id
: name, description, state. dateLaMu. userLaMu. category
PersonTemplate ( ).
```

```
(Consumer id-^Customer" >
<name>Role as customer</name>
(description) » xmeHTa</description>
<state>active</state>
dateLaMu»2008-01-23T00:00:00Z</dateLaMu»
```

```
(userLaMu>bape</userLaMu>
</Consumer>
```

```
<RoleType id="Consumer" >
  <descr1 1 0 </description>
  <startDate>2008-01-23T00:00:00Z</startDate>
  <endDate>2006-12-31T00:00:00Z</endDate>
  <state>active</state>
  <dateLaMu>2008-01-23T00:00:00Z</dateLaMu>
  <userLaMu>bape</userLaMu>
</RoleType>
```

### B.3.12 TransactionPhaseTemplate

```
  : id
  : name, description, dateReached, state, dateLaMu, userLaMu
  : transaction
```

```
<WaitForMenu id="tp003" >
  <name>___</name>
  <description>Oasa ...</description>
  <dateReached>2008-02-04T00:00:00Z</dateReached>
  <state>active</state>
  <dateLaMu>2006-02-04T00:00:00Z</dateLaMu>
  <userLaMu>bapa</userLaMu>
</WaitForMenu>
```

```
<TransactionType id="ObtainMenuTransaction" >
  <descr1 1 > MftHx/description>
  <startDate>2008-01-23T00:00:00Z</startDate>
  <endDate>2008-12-31T00:00:00Z</endDate>
  <state>active</state>
  <dateLaMu>2008-01-23T00:00:00Z</dateLaMu>
  <userLaMu>bapa</userLaMu>
  <initiator>
    <RoleTypeRef idref="Consumer"/ >
  </initiator>
  <executor>
    <RoleTypeRef idref="Employee"/ >
  </executor>
</TransactionType>
```

```
<TransactionPhaseType id="SfaitForMenu" >
  <description>Mems , AaHO</description>
  <startDate>2008-01-23T00:00:00Z</startDate>
  <endDate>2008-12-31T00:00:00Z</endDate>
  <state>active</state>
  <dateLaMu>2008-01-23T00:00:00Z</dateLaMu>
  <userLaMu>bapa</userLaMu>
</TransactionPhaseType>
```

### B.3.13 TransactionTemplate

```
  : id
  : number, name, description, startDate, endDate, state, dateLaMu, userLaMu, result
  : initiator, executor
  , Message Templates ( ),
```

```
<ObtainMenuTransaction id="TheTransaction" >
  <number>001</number>
  <name>_ </name>
  <description>_____ </description>
```

```

«startDate»20Q8-01-23TQO:00:00Z«/startOate»
«endDate»2008-01-23T00:00:00Z«/endOate»
<state»active</state>
<dateLaMu»2008-01-23T00:00:00Z«/dateLaMu»
«userLaMu»bapa«/userLaMu»
«initiator»
  «PersonInRoie id-"_____ " »
  «/PersonInRoie»
«/initiator»
«executor»
  «PersonInRoie >
  «/PersonInRoie»
«/executor»
«/ObtainMenuTransactlon»

```

:

```

«TransactionType Id-"ObtainMenuTransaction" >
  «description»Tpan3aKUK4 /description»
  <etartDate>2008-01-23T00:00:00Z</startDate>
  <endDate»2a08-12-31TOO:0a:OOZ«/endDate»
  <state»active«/state»
  <dateLaMu»2008-01-23TOO:OO:00Z«/dateLaMu»
  <userLaMu»bapa</userLaMu»
  «initiator»
    «RoleTypeRet Idref-"Consuo,er^7 >
  «/initiator»
  «executor»
    «RoieTypeRef Idrer-" / >
  «/executor»
«/TransactionType»

```

B.4

B.4.1 Id

XML-

(http J www.w3.ocg/XMU)

(GUID) ( XML  
 ).  
 \* \_\*

.5

.5.1 Abbreviation

abbreviation ( ). abbreviation  
 ( )

.5.2 category

«... id»".."»

«category»...«/category»

</...»



**.5.3 creationDate**

```

      —
      :
<... id-*...* >
  <creationDate>2007-12-03T00:00:00Z</creationDate>
</...>

```

**.5.4 dateLaMu**

```

      —
      :
«... id-~...» >
  <dateLaMu>2007-12-03T00:00:00Z</dateLaMu>
</...>

```

**.5.5 dateReached**

```

      'dateReached' —
      /
      —
      :
... id-*...» >
  <dateReached>2007-02-04T00:00:00Z</dateReached>
</...>

```

'TransactionPhaseTemplate".

**.5.6 dateRead**

```

      —
      :
«... id-*...» >
  <dateRead>2007-12-03T00:00:00Z</dateRead>
</...>

```

**.5.7 dateSend**

```

      —
      :
<... id-*...» >
  <dateSend>2007-12-03T00:00:00Z</dateSend>
</...>

```

**8.5.8 description**

```

      —
      :
<Projectexecutor Id-*THO* >
  <description>...</description>
</Projectexecutor>

```

**B.5.9 documentidentification**

( . .5.13).

10.0.04—2019

.5.10 documentReference

.5.11 documentversion

.5.12 endDate

<... id-"..." ?  
<endDate?2007-12-03</endDate?

</...?

.5.13 fileLocation

<... id-"..." ?  
<fileLocation?\\sx v~path\Public\proJect-x\docs\fileLocat ion?

</...?

.5.14 fileType

( . . . .5.9).  
MIME (Multipurpose Internet Extensions).

<... id-"..." ?  
<fileType?text/plain</fileType?

</...>

.5.15 fileVersion

. id-"..." >  
<fileVersion?20071202</fileVersion?

</... .>

.5.16 identification

<AssignmentConfirmation id-"X" >  
<identification?This message contains the assignment X related to part ^/identification?

</AssignmentConfirraat ion?

B.5.17 initiatingTransactionMeesageK)

.5.18 initiatorToExecutor

<ExampleKessage id-"..." >  
<initiatorToExecutor?false</initiatorToExecutor?  
transaction?  
<ExampleTranaaction id-"..." ?

```

    «initiator»
      «PersonInRole id-"A" »

      «/PersonInRole»
    «/initiator»
    «executor»
      «PersonInRole id-"B" »

      «/PersonInRole»
    «/executor»
  «/ExampleTransaction»
«/transaction»

«/ExampleMessage»

```

ExampleMessage ( ) ( ).

.5.19 language

```

    — :
«... id-"..." >

  «language»EN«/language»

```

```

</...»

8.5.20 name
      (STRING)

```

.5.21 number

— number. ( . ) .

.5.22 objectCode

— , , -

.5.23 result

.5.24 startDate

```

    — :
«... id-"..." >

  «StartDate>2007-12-03</startDate»

```

```

</...»

.5.25 state

```

```

    — :
«... id-"..." >

  <state>active</state>

```

```

</...»

.5.26 userLaMu
      ,
      — PersonTypeInstance.

```

```

    — :
«... id-"..." >

  «userLaMu»Peter Bonsma«/userLaKu»

```

```

</...»

```

.5.27 userName

```

      ,
      {
      }
    )
  <... id-"..." >
    <userName>BAP</userName>
  </...>

```

.5.28 versionNo

```

      ,
      ;
    <... id-"..." >
      <versionNo>23</versionNo>
    <<'...'>

```

.6

.6.1 AppendixGroup

```

      <Appendix id-"..." >
        <<append! xGroup>
          <<AppendixGxoup id-"_____ " >
            </_____ nd i xGroup>
          <<ZappendixGroup>

```

<<ZAppendix>

.6.2 contactPerson

```

      ,
      PersonInRole
    <Organisation id-"..." >
      <<contactperson>
        <<Person id-"_____ " >
          <</Person>
        <</contactPerson>
      <</organisation>

```

PersonType.

.6.3 Executor

PersonInRole.

.6.4 Group

<<AppendixGroup id-"..." >

```

      <<group>
        <<Group id-"..." >
          <</group>
        <</group>

```

<</AppendixGroup>

8  
 .6.5 Initiator  
 PersonInRole.  
 . . Message  
 ,  
 — :  
 «Appendix id-"\_\_\_\_\_ " ?  
 «message?  
 «Message id-"..." >  
 «/Message?  
 «/message?  
 «/Appendix?  
 ,  
 MessageType. AppendixType. Appendix,  
 8.6.7 messageInTransaction Message.  
 8.6.8 Organization PersonInRole.  
 ,  
 — :  
 «PersonInRole id-"... \* ?  
 «organisation?  
 «Organisation id"..." >  
 «/Organisation?  
 «/organisation?  
 «/PersonInRole?  
 ,  
 8.6.9 Role rnnOrganisationType. Organization.  
 ,  
 8.6.10 Substituting PersonTemplate ( ).  
 PersonInRole.  
 — substituting. PersonInRole -  
 PersonInRole.  
 8.6.11 Successor  
 8.6.12 Transaction  
 ,  
 — :  
 «Message id-"...- >  
 «transaction?  
 «Transaction id-"..." >  
 «/Transaction?  
 «/transaction?  
 «/message?  
 ,  
 Transaction. MessageType, Message,  
 Transaction.

( )

.1

( . 4).

- .
- 
- 
- 
- 

.2

- - 
  -
- CR1: Client; ( )  
 - R1: Project leading; ( )  
 • R2: System engineering; ( )  
 - R3: 3D engineering; ( )  
 • R4: Cost engineering ( ).

.1 —

1	CR1	R1
2	R1	R2
	R1	R3
4	R1	R4

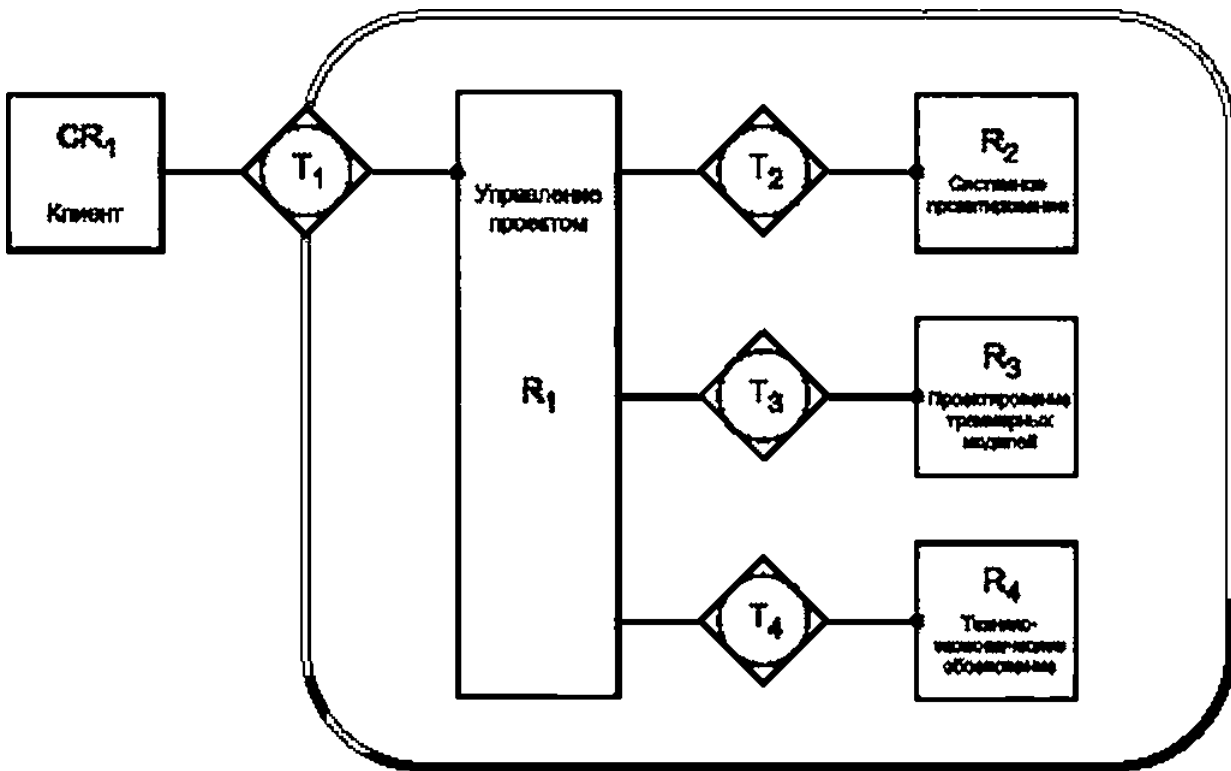

.1 —

.2.1 RoleType

RoleTypes. RoleType

roleType).

XML ( ).

\$. ...)\*

roleType),

).

( .

XML):

```

•RoleType id«CRI_CIAent» >
  <descr iptlорrCRI: description»
  <stdrtDate»2010-10-29T00:00:00.000*02:00</startDate»
  <endDate»2099-10-2<' * J: j u. nuu* :OC</endDate»
  <state»active-'/state»
  <dateLaMu»2010-10-29T00:00:00.000*02:00< ZdateLaMu»
  «userLaHu»Ronald- /userLaMu»
  <language» «/language»
  <category» «/category»
  <helpInfo» «/helpInfo»
  <code» «/code»
  «responsibilityScope»Hecee
  «/responsibilityscope»
  cresponsibilityTaskx/responsibiityTask»
  <r esponsibl 11 tySupportTaskx/r esponsibi 11 tySuppor tTask»
  «responsibilityFeedbackx/responsibilityFeedback»
«/RoleType»
«RoleType id-"RI_Project_Leading" >
  <description»RI: .description»
  <startDate»2010-10-29T00:00:00.000+02:00</startDate»
  
```

```

<endDate?2099-10-29T00:00:00.000*02:00</endDate?
<state>active-/state?
<dateLaMu>2010-10-29T00:00:00.000*02:00-/dateLaMu?
«user LaMu>Ronald-/user LaMu?
«language?</language?
<category?</category?
<helpInfo?</helpInfo?
<code?</code?
«responsibilityScope?nonxeH
*/responsibilityScope?
«responsibilityTask?</responsibilityTask?
«responsibilitySupportTask?</responsibilitySupportTask?
<responsibilityFeedback?</responsibilityFeedback?
«/RoleType?
«RoleType id="R2_System_Engineering" >
  <description>R2:                               -/description?
  <startDate>2010-10-29T00:00:00.000+02:00</startDate?
  «endDate?2099-10-29T00:00:00.000*02:00</endDate?
  «state>active-/state?
  <dateLaMu>2010-10-29T00:00:00.000*02:00-/dateLaMu?
  «user LaMu>Ronald-/user LaMu?
  <language></language?
  «category?</category?
  <helpInfo?</helpInfo?
  «code?</code?
  <responsibilityScope?QojrKeM
    */responsibilityScope?
  <responsibilityTask?</responsibilityTask?
  «responsibilitySupportTask?</responsibilitySupportTask?
  <responsibilityFeedback?</responsibilityFeedback?
«/RoleType?
«RoleType id="R3_3D_Engineering" ?
  <description?R3:                               /description?
  <startDate>2010-10-29T00:00:00.000+02:00</startDate?
  <endDate?2099-10-29T00:00:00.000+02:00</endDate?
  «state>active-/state?
  <dateLaMu>2010-10-29T00:00:00.000+02:00-/dateLaMu?
  «userLaMu?Ronald</userLaMu?
  «language?</language?
  «category?</category?
  <helpInfo?</helpInfo?
  <code?</code?
  <responsibilityScope?nonxeH
    */responsibilityScope?
  «responsibilityTask?</responsibilityTask?
  «responsibilitySupportTask?</responsibilitySupportTask?
  <responsibilityFeedback?</responsibilityFeedback?
«/RoleType?
«RoleType id="R4_Cost_Engineering" ?
  <description>R4:                               -/description?
  «startDate?2010-10-29T00:00:00.000+02:00</startDate?
  «endDate?2099-10-29T00:00:00.000+02:00</endDate?
  <state>active-/state?
  <dateLaMu>2010-10-29T00:00:00.000+02:00-/dateLaMu?
  «user LaMu>Ronald</user LaMu?
  <language?</language?
  <category?</category?
  <helpInfo?</helpInfo?
  <code?</code?
  <responsibilityScope?noj>cew
    */responsibilityScope?
  <responsibilityTask?</responsibilityTask?

```



```

«responsibilitySupportTask/xresponsibilitySupportTask»
<responsibilityFeedback></responsibilityFeedback>
</RoleType>

```

.3

.3.1 TransactionType

- TransactionType ( TransactionType).
- TransactionType ( TransactionType).
- TransactionType ( TransactionType).
- RoleType. TransactionType.

XML:

- 1: ;
- 2: ;
- : 30- ;
- 4: .

```

«TransactionType id»~T1~ »
«description»T1 «/description»
«startDate»2010-10-29T00:00:00.000+02:00</startDate>
«endDate»2099-10-29T00:00:00.000+02:00</endDate>
«state»active</state>
«dateLaMu»2010-10-29T00:00:00.000+02:00</dateLaMu>
«userLaHu»Ronald</userLaMu>
«language»/language»
«category»</category>
<helpInfo></helpInfo>
«code»/code>
<result»npoeKT */result»
«initiator»
«RoleTypeRef Idref="CRI_Client"/ »
</initiator»
«executor»
«RoleTypeRef Idref="RI_P oject_Leading"/ »
</executor»
</TransactionType>

```

```

«TransactionType id--T2" >
«description»T2 «/ description»
<startDate>2010-10-29T00:00:00.000D+02:00</startOate>
«endDate»2099-10-29T00:00:00.000+02:00</endDate>
<state>active</state>
«dateLaHu»2010-10-29TOD:00:00.000+02:00</dateLaHu>
«usexLaMu»Ronald</userLaMu>
«language»/language»
cca tego ></ tego >
«helpInfo»</helpInfo>
<code»</code>
«
</ £
«initiator»
«RoleTypeRef idref="RI_Project_Leading"/ »
</initiator»
«executor»
«RoleTypeRef Idref="R2_System_Engineering"/ »
</executor»
</TransactionType>

```

```

«TransactionType -^ " »
«description»T3 3P-MOAenn</description»
<startDate>2010-10-29T00:00:00.000+02:00</startDate>

```

```

<endDate>2099-10-29T00:00:00.000+02:00</endDate>
<state>active</state>
<dateLaMu>2010-10-29T00:00:00.000+02:00</dateLaMu>
<userLaMu>Ronald</userLaMu>
«language»*/language»
«category»</category>
«helpInfo/helpInfo»
«code»</code>
«result»30-          «/  11»
«initiator»
    «Role Type Ref Idref~~RI_Project_Leading"/ >
</initiators
«executor»
    «RoleTypeRef idref£' "R3_3D_Engineering"*/ »
</executors
«/TransactionType>
«TransactionType id-^T-I" »
    «description»T4          cTOKMOCTx</description>
    <startDate>2010-10-29T00:00:00.000+02:00</startDate>
    <endDate>2099-10-29T00:00:00.000+02:00</endDate>
    « state>active</state>
    <dateLaMu>2010-10-29T00:00:00.000+02:00</dateLaMu>
    «userLaMu>Ronald</userLaMu>
    «language»*/language»
    <categoryx/category>
    «helpInfo/helpInfo»
    <code/code>
    «          «/  1 >
    «initiator»
        «RoleTypeRef idref£"RI_ roject_Leading"/ >
    </initiator>
    «executor»
        «RoleTypeRef idref£-"R4_Cost_Engineering"/ »
    </executor>
</TransactionType>
    IDM          ,          (          ),          ,
(          ).
    TransactionType,          * Deliver 3D model' (          30-          ).
        R1 Project leading (          )
        R3.
            8
.3.2 TransactionPhaseType
    TransactionType
    TransactionPhaseType TransactionPhaseType TransactionType
    TransactionPhaseType TransactionPhaseType
    TransactionPhaseType.
3:
•          ;
•          ;
•          ;
•          ;
•          ;
•          ;
    TransactionPhaseType
XML:
«TransactionPhaseType id-"Desired_Result" »
    «deset; :.>          -/description»
    <startDate>2010-10-01T00:00:00.000+02:00</startDate>
    <endDate>2099-10-01T00:00:00.000+02:00</endDate>
    «state active-;/state»
    <dateLaMu>2010-10-01T00.-00:00.000+02:00</dateLaMu>
    <userLaMu>Ronald</userLaMu>

```

```

elanguage?e/language?
< tego ></ tego >
<helpInfo?e/helpInfo?
ecode?-e/code?
/TransactionPhaseType?
«TransactionPhaseType -J-"Raault_Accepted" >
  «descr 1 ^ > -description?
  estartDate>2010-11-04T00:00:00.000+01:00«/startDate?
  «endDate?2099-11-04T00:00:00.000+01:00</endDate?
  <state>active</state?
  <dateLaMu?2010-11-04T00:00:00.000+01:00</dateLaMu?
  «user LaMu>Ronald- /usee LaMu?
  clanguage?c/language?
  ccategory?«/category?
  <helpInfo?«/helpInfo?
  ecode?-«/code>
«/TransactionPhaseType?
«TransactionPhaseType id:-"Result_Produced" ?
  «description; - - /description?
  cstartDate?2010-10-01T00:00:00.000+02:00</startDate?
  <endDate?2099-10-01T00:00:00.000+02:00</endDate?
  estate>active</state?
  edateLaMu?2010-10-01T00:00:00.000+02:00</dateLaMu?
  «user LaMu?Ronald- /user LaMu?
  clanguage?c/language?
  ecategory?«/category?
  <helpInfo?«/helpInfo?
  <code?-</code>
«/TransactionPhaseType?
«TransactionPhaseType id-"Result_Produced" ?
  «description; - - /description?
  <startDate>2010-10-01T00:00:00.000+02:00</startDate?
  <endDate?2099-10-01T00:00:00.000+02:00</endDate?
  estate>active</state?
  edateLaMu?2010-10-01T00:00:00.000+02:00</dateLaMu?
  <userLaMu>Ronald/userLaMu?
  elanguage?e/language?
  ecategory?e/category?
  ehelpInfo?e/helpInfo?
  ecode?-e/code?
«/TransactionPhaseType?
«TransactionPhaseType id-"Result_Requested" >
  «description; - - description?
  estartDate>2010-10-01T00:00:00.000+02:00e/startDate?
  eendDate?2099-10-01T00:00:00.000+02:00e/endDate?
  estate>active</state?
  edateLaMu?2010-10-01T00:00:00.000+02:00e/dateLaMu?
  euser LaMu>Ronald- /userLaMu?
  elanguage?e/language?
  ecategory?e/category?
  <helpInfo?«/helpInfo?
  ecode?-e/code>
«/TransactionPhaseType?
«TransactionPhaseType id-"Result_Stamped" ?
  «description; - -- description?
  cstartDate?2010-11-04T00:00:00.000+01:00e/startDate?
  eendDate?2099-11-04T00:00:00.000+01:00</endDate?
  estate>active</state?
  edateLaMu?2010-11-04T00:00:00.000+01:00e/dateLaMu?
  euser LaMu?Ronald- / use rLaMu?
  elanguage?e/language?
  ecategory?e/category?

```

```

«helpInfo*«/helpInfo*
«code*«/code*
«/TransactionPhaseType*
    
```

C.3.3 MessageType

```

        ,
        . MessageType
        (
        ).
        /
        ComptexElementype.
        SimpleEtementype.
        MessageType
        XML.
        5 8      3:
        .
        .
        .
        .
        -
«MessageType id="Request_for_3D_model" >
«description>3anpoc 30- </description*
<startDate>2010-11-04T00:00:00.000+01:00*/startDate*
<endDate>2099-11-04T00:00:00.000+01:00</endDate*
<state>activ«-/state*
«dateLaMu*2010-11-04T00:00:00.000+01:00</dateLaMu*
«user LaMi:--Ronald*/user LaMu*
<language*«/language*
«categoryx/category*
<helpInfo*«/helpInfo*
<code*«/code*
«complexElements*
<CcnplexEleentTypeRef idref="ReaultRequettedCcag>lexElement"/ >
«CocnplexEleentTypeRef idref="WorkIdentiicationComplexElement"/ *
«CccnplexElementypeRef idref="WorkSpecificationComplexElement"/ >
«CocnplexEleentTypeRei idrei="RemarkeComplexElement" *
«CccnplexElementypeRef idreE="l>eadlineCcnplaxElement" ' >
«/complexElements*
«/MessageType*
«MessageType id="Work_done_and_requesL_approval" *
«description* «/description*
« startOate*2010-11-04T00:00:00.000+01:00;/s tar tDate*
<endDate>2099-11-04T00:00:00.000+01:00</endOate*
«statoactive/state*
<dateLaMu>2010-11-04T00:00:00.000+01:00</dateLaMu>
«user-Ronald*/;userLaMu*
«language*«/language*
«categoryx/category*
«helpInCox/helpInfo*
«code*«/code*
«complexElements*
«ComplexElementypeRef idret="Raqua8tApprovalCoaplexElement" >
«ComplexElementypeRet idref="RaBark8CeeplajtEleaent" *
«ComplexElementypeRef idref="DaadIlfMCoaplxElamant" * *
«ComplexElementypeRef idret="WorkIdentificationCoag>lexElement"/ *
«ComplexElementypeRef idref="WorkSpecificationCc«g>lexElestent" / *
</complexElements*
«/MessageType*
«MessageType id="Request_adjusstnents" * *
«description- -.'description*
<startDate>2010-11-04T00:00:00.000+01:00-/startDate*
<endDate>2099-11-04T00:00:00.000+01:00</endDate*
«state>active-/state*
<dateLaMu*2010-11-04T00:00:00.000+01:00</dateLaMu*
«user LiMu --Ronald*/;userLaMu*
    
```

```

«language»*/language»
< tgo / tgo >
«helpInfo/helpInfo»
«code»-«/code»
«complexElements»
  «ComplexElementRef idref="RequestAdjustmentComplexElement"/ >
  «ComplexElementRef idref="RemarksComplexElement"/ >
  «ComplexElementRef idref="DeadlineComplexElement"/ >
  «ComplexElementRef idref="WorkIdentificationComplexElement"/ >
  «ComplexElementRef idref="WorkSpecificationComplexElement"/ >
«/complexElements»

```

```

«MessageType
  :J-"Work_approved" >
  «description - ' description»
  <startDate>2010-11-04T00:00:00.000+01:00</startDate»
  <endDate>2099-11-04T00:00:00.000+01:00</endDate»
  «state>active</state»
  <dateLaMu>2010-11-04T00:00:00.000+01:00</dateLaMu»
  «userLaMu>Ronald</userLaMu»
  <language>«/language»
  «category»*/category»
  «helpInfo/helpInfo»
  <code>-«/code»
  «complexElements»
    «ComplexElementRef idref="ApprovalComplexElement"/ >
    «ComplexElementRef idref="RemarksComplexElement"/ >
    «ComplexElementRef idref="WorkIdentificationComplexElement"/ >
    «ComplexElementRef idref="WorkSpecificationComplexElement"/ >
  « / complexElements »

```

```

«/Mess
»
«MessageType i<.-"Work_not_approved"»
  «descriptionSaAune -/description»
  <startDate>2010-11-04T00:00:00.000+01:00</startDate»
  <endDate>2099-11-04T00:00:00.000+01:00</endDate»
  «state>active-/state»
  <dateLaMu>2010-11-04T00:00:00.000+01:00</dateLaMu»
  «user LaMu>Ronald-/userLaHu»
  «language*/language»
  «categoryx/category»
  «helpInfo/helpInfo»
  <code>-«/code»
  «complexElements»
    «ComplexElementRef idref="DisapprovalComplexElement"/ >
    «ComplexElementRef idref="RemarksComplexElement"/ >
    «ComplexElementRef idref="WorkIdentificationComplexElement"/ >
    «ComplexElementRef idref="WorkSpecificationComplexElement"/ >
  «/complexElements»

```

```

«/MessageType»

MessageType
messageType transactionType : MessageInTransactionType.
.3.4 MessageInTransactionType

MessageInTransactionType MessageTypes TransactionTypes.
MessageType TransactionType.
MessageInTransactionType
:
• { MessageInTransactionType).
• { = true:
= false),
• MessageInTransactionType.
• MessageType ( MessageInTransactionType),
• ( ) TransactionType MessageInTransactionType.

```

```

- TransactionPhase ( ),
TransactionType.
- GroupType.
XML
MessageInTransactionType
5 ( ISO 29481-2 IDM. 2 ; 3).
XML ; TransactionType
MessageInTransactionType.
MessageInTransactionType 'MessageInTransaction!'.
MessageInTransaction! * ( = true).
MessageInTransactionType.
'MessageInTransaction2*.
MessageInTransactionType ' 5 ,
.
.
MessageInTransactionType ( 1 3)
MessageInTransactionType2. MessageInTransaction2 « ( -
- false).
«MessageInTransactionType Id-^MessageInTransaction1" >
<requiredNotify>0</requiredNotify>
<dateLaMu>2010-11-05T00:00:00.000+01:00</dateLaMu>
«userLaMu 'Ronald' / userLaMu»
<received>0</received>
<send>0</send>
<state>0</state>
<initiatorToExecutor -'true-' / initiatorToExecutor>
«message»
«MessageInTransactionTypeRef idref="Request_for_3D_model" / >
</message>
«transaction»
«TransactionTypeRef idref="T3" / >
</transaction>
«transactionPhase»
«TransactionPhaseTypeRef idref="Result_Requested" / >
</transactionPhase>
«group»
«GroupTypeRef idref="StandardGroup" / >
</group>
</MessageInTransactionType>
«MessageInTransactionType Id-^NaesagalaTsaneaetla2" >
«requiredNotify»0</requiredNotify>
<dateLaMu>2010-11-05T00:00:00.000+01:00</dateLaMu>
«userLaMu - 'Ronald' - / userLaMu»
<received>0</received>
<send>0</send>
<state>0</state>
<initiatorToExecutor>false</initiatorToExecutor>
«message»
«MessageInTransactionTypeRef idref="Work_done_and_request_approval" / >
</message>
«previous»
«MessageInTransactionTypeRef idref="MessageInTransaction1" / >
«MessageInTransactionTypeRef idref="MessageInTransaction2" / >
</previous>
«transaction»
«TransactionTypeRef idref="T3" / >
</transaction>
«transactionPhase»
«TransactionPhaseTypeRef idref="Result_Produced" / >
</transactionPhase>
«group»
«GroupTypeRef idref="StandardGroup" / >
</group>
</MessageInTransactionType>

```

.3.5 AppendixTypes

```

    ( BIM)
    AppendixType
    XML
    AppendixType.
    SimpleElement Type ComplexElement Type AppendixComplexElement'.
    «AppendixType Id="" StandardAppendixType" >
    «description' "description?
    «StartDate>2010-10-01T00:00:00.000*02:00'/startDate?
    <endPate?2099-10-01T00:00:00.000*02:00</endPate?
    «state -active-/state?
    «dateLaMu?2010-10-01T00:00:00.000+02:00</dateLaMu?
    <userLaMu>Ronald'/user La Mu >
    <language?«/language?
    <category?«/category?
    <help:n&o?«/helpXnto?
    «complexElenents?
    «ComplexElement TypeRef Ldxef-" AppendixCoatpiexEieinent"? ?
    «/coeplexElenents?
    «/AppendixType?
  
```

C.3.6

```

    MessageType :
    • MessageType;
    •
    MessageType
    ComplexElement Type.
    ComplexElement Type SimpleElement Type SimpleElement Type
    SimpleElement Type ( UserDefinedType
  
```

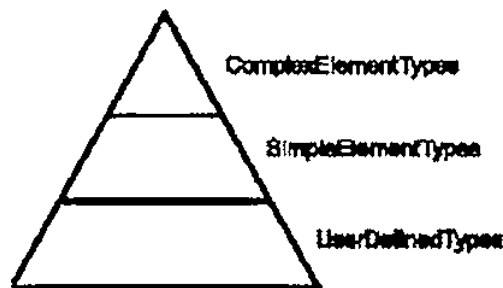

.2 —

.3.7

ComplexElement Type  
ComplexElement Type

- 
- ( XML)
- (post-schema-validadabon infoset)
- 
- 

```

    ( MessageType
    ), MessageType «1
  
```

ComplexElement Type:

- resultRequestedComplexElement;
- workIdentificationComplexElement:
- workSpecificationComplexElement
- remarksComplexElement;
- deadlineComplexElement.

ComplexElementType 'WorkSpecificabon' XML. ComplexElementType - ComplexElementType,

XML- ComplexElementType 'WorkSpecificationComplexElement' SimpleElementType:

ComplexElementType  
 • ScopeOfWork:  
 - CostEstimation.

«ComplexElement id="WorkSpecificationComplexElement" >  
 «description -description\*  
 <startDate>2010-10-01T00:00:00.000+02:00</startDate\*  
 <endDate>2099-10-01T00:00:00.000+02:00</endDate\*  
 «state active- / state\*  
 <dateLaMu>2010-10-01T00:00:00.000+02:00</dateLaMu>  
 «user i.iM -Ronald\*/userLaMu\*  
 «language\*\*/language\*  
 <category\*7 category\*  
 «helpInfo/helpInfo\*  
 «simpleElements\*  
 «SimpleElementTypeRef idref="ScopeOfWork"/ \*  
 <SimpleElementRef idref="CostEstimation"/ \*  
 </simpleElements\*  
 </ComplexElement type\*  
 .3.8 SimpleElementType  
 SimpleElementType :  
 •  
 •

XML SimpleElementType:  
 CostEstimation. SimpleElementType  
 ComplexElementType 'WorkSpecificationComplex  
 Element' ( ).  
 «SimpleElement id="CostEstimation" \*  
 «description\*0ueHxa \*/description\*  
 «interfaceType/\*  
 <state\*active</state>  
 <dateLaMu>2010-12-10T12:36:02.527+01:00</dateLaMu>  
 «userLaMu\*Ronald</userLaMu\*  
 «language/\*  
 «category/\*  
 « 1 1 £ \* «/helpInfo\*  
 «valueList/\*  
 «UserDefinedType\*  
 «UserDefinedTypeRef idref="EURO" \* >  
 «/UserDefinedType\*  
 </SimpleElement type\*  
 .3.9 UserDefinedType  
 UserDefinedType (  
 datatype). XML  
 UserDefinedType 'STRING'  
 EURO'. XML UserDefinedType. -  
 :  
 •  
 •  
 • baseType.  
 • XSD (  
 ).  
 - «UserDefinedType id="EURO" \*  
 «description\*Euro- .-description\*  
 «state-active- /state\*  
 <dateLaMu>2010-12-10T12:35:19.485+01:00</dateLaMu\*  
 «user LaMu -Ronald---/userLaMu\*  
 •-b.is-rType>DECIMAL--' .-'baseType\*  
 «xsdRestrictionXfa:fractionDigits value="2"/ > </xsdRestriction >



```
( 1 £ > « h , (/ 1 1 1 *  
(/User DeJinedT >  
- <UsexDefinedType Ld~"STRING" *  
(description-CxpoxM 'description*  
(state>active-/state*  
(dateLaMu*2010-10-01T00:00:00</dateLaMu*  
«user LaMii >Ronald- /user LaMu *  
(baseType>STRING-;/baseType>  
(xsdRestrIotion /*  
(Language />  
<heiplInfo*Tnn String XML. ' '  
- ./heiplInfo*  
(/User DetinedType*  
.3.10
```

ElementType.

XSD.

4.8.

( D )

D.1

XML. XSD. ,  
( " " ) -  
(RoleType. TransactionType. MessageType. ComplexElementType. SimpleElementType . .)  
XSD. , ID , -  
XSD XML. , ID XSD. -  
ID - ID = "Rote003". -  
ID = "ProjecI\_Manager". -  
XSD , MessageType -  
XSD -  
( ).

( )

ISO 29481-1		10.0.03—2019/ 29481-1:2016 « 1.»

10.0.04—2019

[1] Dietz J.L.G. (2006). *Enterprise Ontology: Theory and Methodology*. Springer,

1.240 c.. ISBN: 3540291695

004.9:006.354

91.010.01

35.240.67

35.240.01

· : , , , , , -

6—2019/8

06.06.2019.

10.07.2019.

60\*84t'g.

. . . 6.84 .- . . 8.00.

,

\*

«

. 117418

- . . 31. . 2.

[www.gosiinfo.ru](http://www.gosiinfo.ru) [info@goslinfa.ru](mailto:info@goslinfa.ru)